

Raymarine®



LIGHTHOUSE SPORT

VERSION 3.8XX

Advanced operation instructions

English (en-US)
Date: 03-2019
Document number: 81388-1
© 2019 Raymarine UK Limited

Trademark and patents notice

Raymarine, Tacktick, Clear Pulse, Truzoom, SeaTalk, SeaTalk^{hs}, SeaTalkng, and Micronet, are registered or claimed trademarks of Raymarine Belgium.

FLIR, LightHouse, DownVision, SideVision, RealVision, HyperVision, Dragonfly, Element, Quantum, Axiom, Instalert, Infrared Everywhere, The World's Sixth Sense and ClearCruise are registered or claimed trademarks of FLIR Systems, Inc.

All other trademarks, trade names, or company names referenced herein are used for identification only and are the property of their respective owners.

This product is protected by patents, design patents, patents pending, or design patents pending.

Fair Use Statement

You may print no more than three copies of this manual for your own use. You may not make any further copies or distribute or use the manual in any other way including without limitation exploiting the manual commercially or giving or selling copies to third parties.

Software updates



Check the Raymarine website for the latest software releases for your product.
www.raymarine.com/software

Product documentation



The latest versions of all English and translated documents are available to download in PDF format from the website: www.raymarine.com/manuals.
Please check the website to ensure you have the latest documentation.

Publication copyright

Copyright ©2019 Raymarine UK Ltd. All rights reserved.

Contents

Chapter 1 Important information	9
Disclaimers	9
Open source license agreements	9
Warranty registration.....	9
Technical accuracy.....	10
Chapter 2 Document and product information.....	11
2.1 Product documentation.....	12
Applicable software version	12
Compatible displays	12
User manuals Print Shop	13
Chapter 3 General information.....	15
3.1 Document conventions	16
3.2 Databoxes	17
Editing databoxes	17
Data items.....	18
3.3 Menu types.....	20
Controls and settings.....	21
Chapter 4 Set up.....	23
4.1 Display controls	24
Switching on and off at the breaker.....	25
Switching active app.....	25
4.2 Getting started.....	26
Startup wizard.....	26
First power up Limitation on Use acknowledgement	26
Configuring transducer settings	26
Identifying engines	27
Performing a settings or factory reset.....	27
Importing user data.....	28
4.3 Shortcuts.....	29
Taking a screenshot	29
Adjusting brightness.....	29
Changing the display's color theme	30
Disabling and enabling sonar ping	30
4.4 Memory card compatibility.....	31
Removing MicroSD card from its adaptor.....	31
Inserting a MicroSD card	32
Removing the MicroSD card.....	32
4.5 Software updates	33
Identify display variant and software version.....	33

Identifying software versions of connected products.....	33
Updating display software using a memory card.....	34
Updating software using an internet connection.....	35
4.6 User data import and export.....	36
Saving user data	36
Importing user data.....	36
4.7 EV-1 heading sensor.....	37
Manually adjusting an EV-1 heading sensor	37
Restarting calibration	37
Locking compass calibration	38

Chapter 5 Homescreen 39

5.1 Homescreen overview	40
Accepting the Limitations on Use.....	41
Available apps	41
Assigning app pages to Quicklaunch buttons	41
5.2 Customizing app pages.....	43
5.3 Creating a new app page.....	44
5.4 Satellite navigation / positioning	45
GPS/GNSS status.....	45
GPS/GNSS settings.....	46
Source of position data.....	46
5.5 Status area	47
Status area icons	47
5.6 Timer.....	47
Using the count down timer.....	47
Using the count up timer	48
5.7 Alarms.....	49
Acknowledging alarms	49
5.8 Settings menu.....	51
Selecting display language.....	51
Boat details.....	52
Units of measure.....	52

Chapter 6 Waypoints, Routes and Tracks 55

6.1 Waypoints.....	56
Placing a waypoint (Quick method)	56
Placing a waypoint at your vessel's location.....	56
Placing a waypoint (Detailed method)	57
Moving a waypoint.....	57
Waypoint management.....	58
6.2 Routes.....	62
Creating a Route	62

Autorouting.....	63
Route management	64
6.3 Tracks	66
Creating a track	66
Converting a track to a route.....	66
Track management.....	67
Chapter 7 Chart app.....	69
7.1 Chart app overview	70
Chart app controls	71
Selecting a chart card.....	72
Chart modes	72
View and motion.....	73
Vessel details.....	74
Viewing object information.....	74
Tide station information.....	75
Current station information.....	76
7.2 Navigation	79
Navigating to a waypoint or point of interest.....	79
Restarting cross track error (XTE).....	80
Following a Route	80
Creating a track	81
7.3 Find nearest	82
Search using find nearest.....	83
7.4 RealBathy™	84
Setting up and creating RealBathy contours	84
7.5 Chart settings menu.....	86
7.6 SonarChart™ Live	90
Enabling SonarChart Live	90
Chapter 8 Fishfinder app	91
8.1 Fishfinder app overview	92
Fishfinder app controls	92
Opening the Fishfinder app.....	93
8.2 Fishfinder channels.....	95
Switching channel frequency.....	95
8.3 Placing a Waypoint in the Fishfinder app.....	96
8.4 Sonar scroll back.....	97
Playing back sonar history.....	97
8.5 Fishfinder sensitivity controls	98
8.6 Configuring transducer settings.....	99
8.7 Fishfinder settings menu	100

Chapter 9 Dashboard app	107
9.1 Dashboard app overview.....	108
Switching data page	108
Hiding and showing data pages.....	109
Customizing existing data pages.....	109
Data items.....	110
Dashboard app settings menu.....	111
Chapter 10 Troubleshooting	115
10.1 Troubleshooting.....	116
10.2 Power up troubleshooting.....	117
Performing a power on reset.....	117
10.3 GPS / GNSS troubleshooting.....	119
10.4 Sonar troubleshooting.....	120
10.5 Wi-Fi troubleshooting.....	122
Chapter 11 Technical support	125
11.1 Raymarine product support and servicing.....	126
Viewing hardware and software details (LightHouse™ Sport).....	127
Viewing product information	127
11.2 Learning resources.....	129
Appendix A NMEA 2000 PGNs	131

Chapter 1: Important information



Warning: Product installation and operation

- This product must be installed and operated in accordance with the instructions provided. Failure to do so could result in personal injury, damage to your vessel and/or poor product performance.
- Raymarine recommends certified installation by a Raymarine approved installer. A certified installation qualifies for enhanced product warranty benefits. Contact your Raymarine dealer for further details, and refer to the separate warranty document packed with your product.



Warning: Ensure safe navigation

This product is intended only as an aid to navigation and must never be used in preference to sound navigational judgment. Only official government charts and notices to mariners contain all the current information needed for safe navigation, and the captain is responsible for their prudent use. It is the user's responsibility to use official government charts, notices to mariners, caution and proper navigational skill when operating this or any other Raymarine product.



Warning: Sonar operation

- NEVER operate the sonar with the transducer out of the water.
- NEVER touch the transducer face when the sonar is powered on.
- SWITCH OFF the sonar if divers are likely to be within 7.6 m (25 ft) of the transducer.

Disclaimers

Raymarine does not warrant that this product is error-free or that it is compatible with products manufactured by any person or entity other than Raymarine.

This product uses digital chart data, and electronic information from Global Navigation Satellite Systems (GNSS) which may contain errors. Raymarine does not warrant the accuracy of such information and you are advised that errors in such information may cause the product to malfunction. Raymarine is not responsible for damages or injuries caused by your use or inability to use the product, by the interaction of the product with products manufactured by others, or by errors in chart data or information utilized by the product and supplied by third parties.

This product supports electronic charts provided by third party suppliers which may be embedded or stored on memory card. Use of such charts is subject to the supplier's End-User Licence Agreement.

Open source license agreements

This product is subject to certain open source license agreements. Copies of the license agreements can be found on the Raymarine website: www.raymarine.com/manuals/.

Warranty registration

To register your Raymarine product ownership, please visit www.raymarine.com and register online.

It is important that you register your product to receive full warranty benefits. Your unit package includes a bar code label indicating the serial number of the unit. You will need this serial number when registering your product online. You should retain the label for future reference.

Technical accuracy

To the best of our knowledge, the information in this document was correct at the time it was produced. However, Raymarine cannot accept liability for any inaccuracies or omissions it may contain. In addition, our policy of continuous product improvement may change specifications without notice. As a result, Raymarine cannot accept liability for any differences between the product and this document. Please check the Raymarine website (www.raymarine.com) to ensure you have the most up-to-date version(s) of the documentation for your product.

Chapter 2: Document and product information

Chapter contents

- [2.1 Product documentation on page 12](#)

2.1 Product documentation

The following documentation is applicable to your product:

All documents are available to download in PDF format from the Raymarine website www.raymarine.com.

Description	Part number
LightHouse Sport Basic operation instructions	81384
LightHouse Sport Advanced operation instructions (This document)	81388
Element HV Installation instructions	87360

Applicable software version

Product software is updated regularly to add new features and improve existing functionality.

This document is applicable to display operating system software: LightHouse™ Sport Release 3.8.

Check the website for the latest software and user manuals:

- www.raymarine.com/software
- www.raymarine.com/manuals

Compatible displays

The LightHouse™ Sport operating system is compatible with the displays listed below.

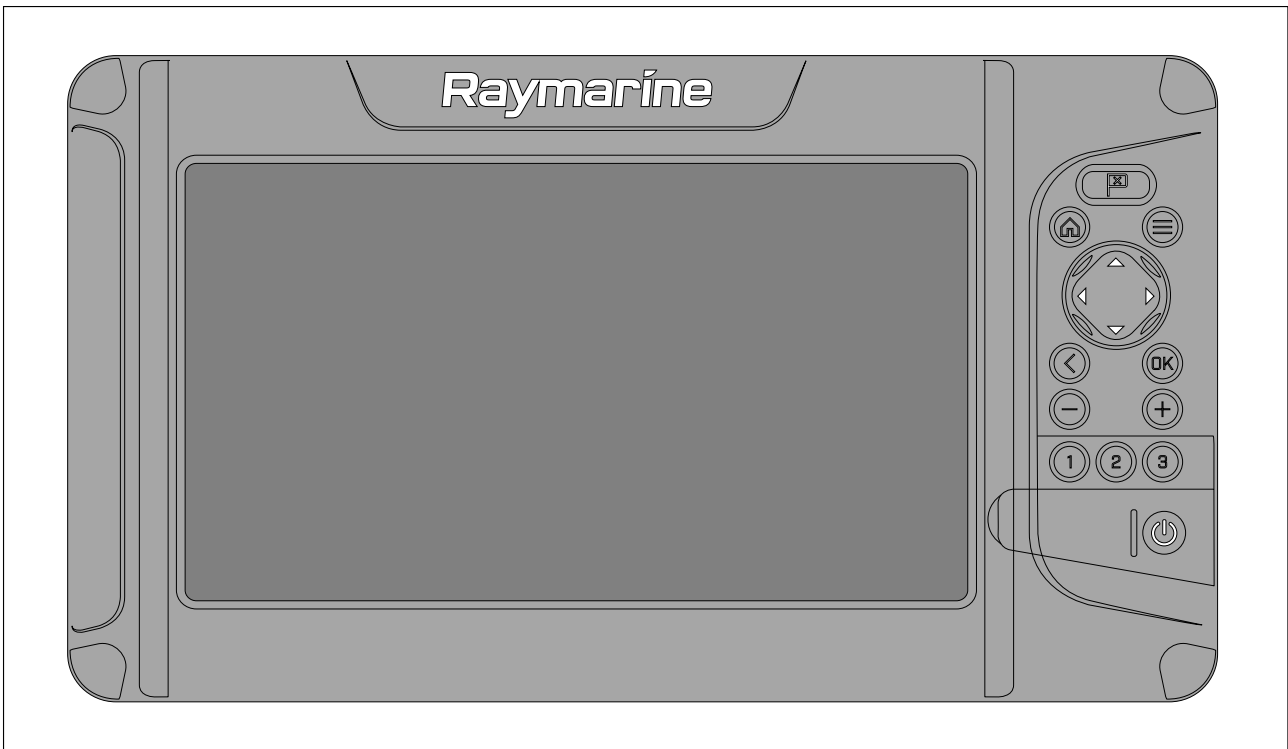

Part number	Description
E70532	Element™ 7 HV HyperVision™ sonar GPS combo.
E70534	Element™ 9 HV HyperVision™ sonar GPS combo.
E70536	Element™ 12 HV HyperVision™ sonar GPS combo.

User manuals Print Shop

Raymarine provides a Print Shop service, enabling you to purchase a high-quality, professionally-printed manual for your Raymarine product.

Printed manuals are ideal for keeping onboard your vessel, as a useful source of reference whenever you need assistance with your Raymarine product.

Visit <http://www.raymarine.co.uk/view/?id=5175> to order a printed manual, delivered directly to your door.

For further information about the Print Shop, please visit the Print Shop FAQ pages: <http://www.raymarine.co.uk/view/?id=5751>.

Note:

- Accepted methods of payment for printed manuals are credit cards and PayPal.
- Printed manuals can be shipped worldwide.
- Further manuals will be added to the Print Shop over the coming months for both new and legacy products.
- Raymarine user manuals are also available to download free-of-charge from the Raymarine website, in the popular PDF format. These PDF files can be viewed on a PC / laptop, tablet, smartphone, or on the latest generation of Raymarine multifunction displays.

Chapter 3: General information

Chapter contents

- [3.1 Document conventions on page 16](#)
- [3.2 Databoxes on page 17](#)
- [3.3 Menu types on page 20](#)

3.1 Document conventions

The following conventions are used throughout this document:

- **Highlight** — The term ‘highlight’ refers to using the **Directional pad** to highlight an item.
- **Select** — The term ‘select’ refers to using the **Directional pad** to highlight an item, and then pressing the **OK** button to select the item.
- **Scroll** — The term ‘scroll’ refers to using the **Directional pad** to move up or down a menu to an item that is not currently shown onscreen.
- **Adjust** — The term ‘adjust’ is used to denote using the **Directional pad** to change a numeric value or slider bar control.



The term ‘select the **Settings** menu’ refers to selecting the settings icon found at the bottom of app menus.

3.2 Databoxes

System data is overlaid onto the Chart, and Fishfinder apps using databoxes located around the edge of the app screen.

Example (Chart databoxes)

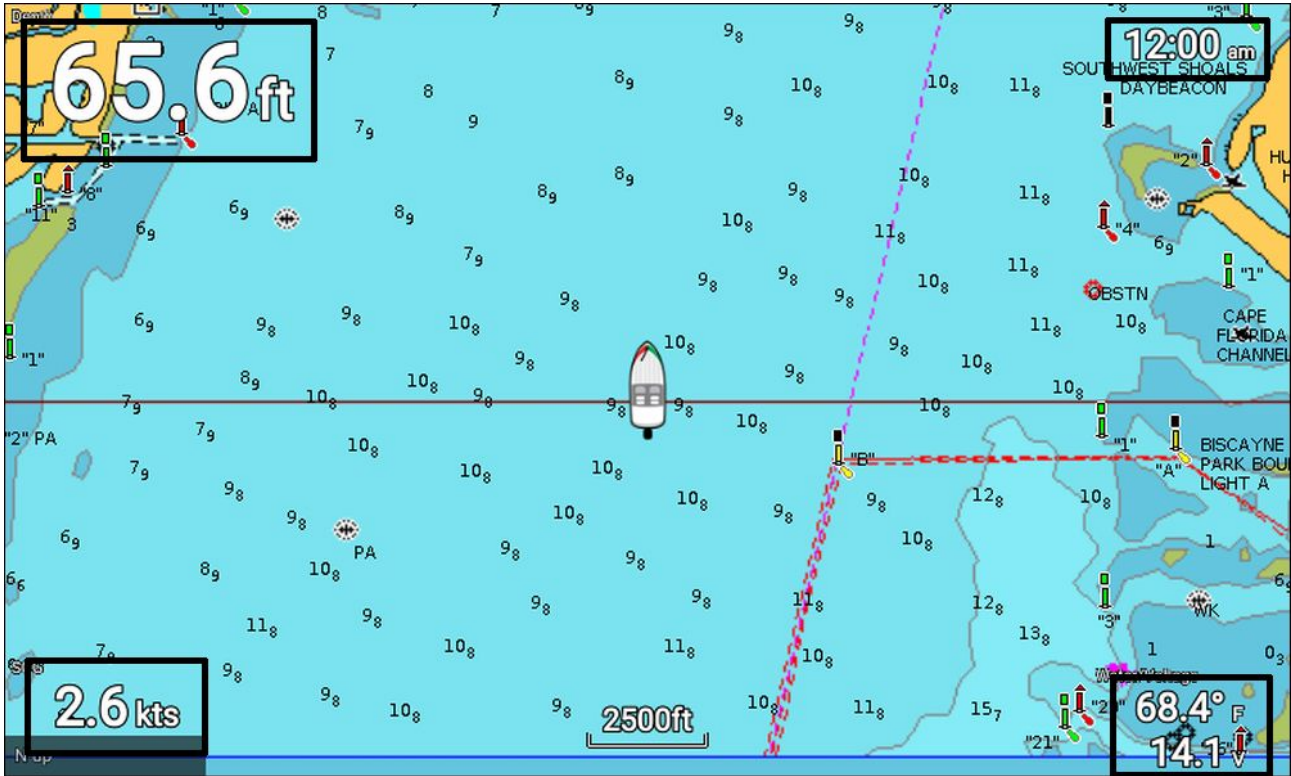

Databoxes can be edited or shown and hidden from the app menu: **Menu > Settings > Databoxes**.

Editing databoxes

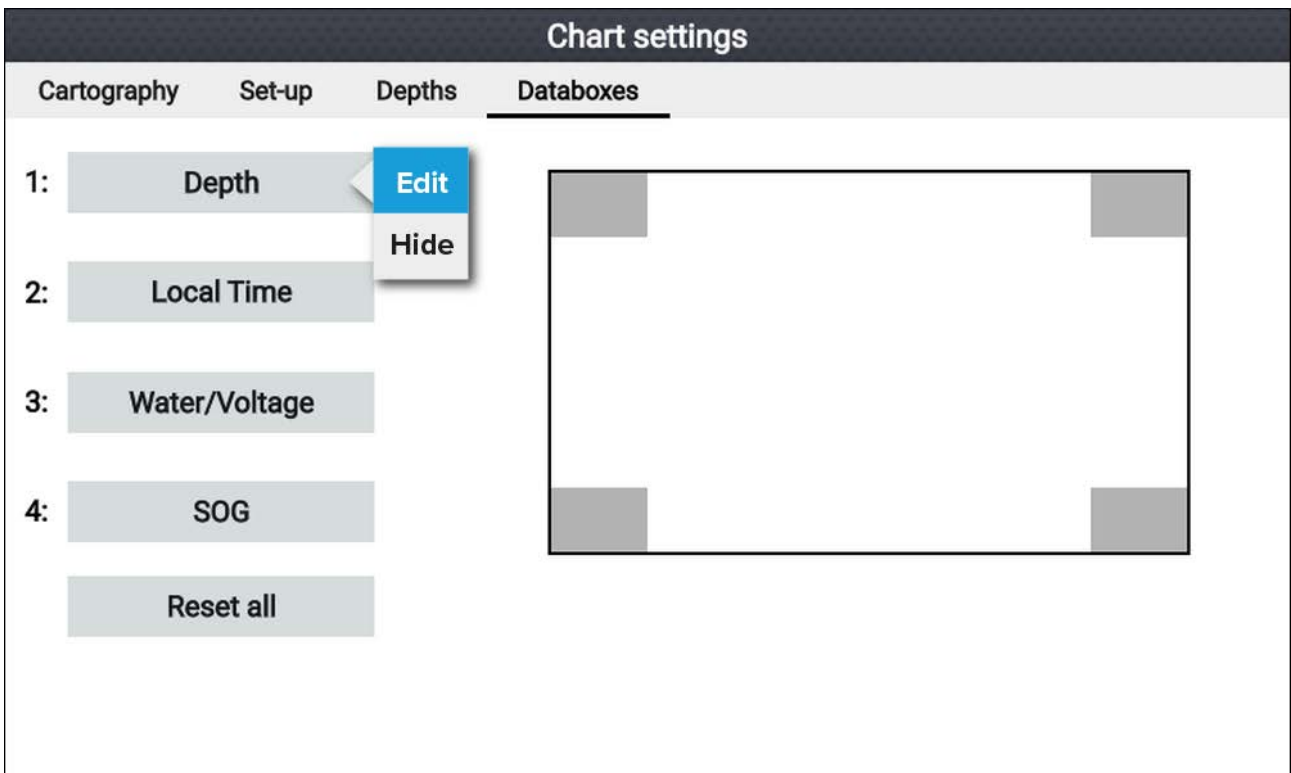

With the app displayed and in focus.

1. Press the **Menu** button.
2. Select the **Settings** icon.
3. Select The **Databoxes** tab.

4. Select the databox you want to edit.
The pop-over menu is displayed.
5. Select **Edit** to change the data item that is displayed in the databox.
6. Select the Data item category.
7. Select the data item.
8. Press the **Menu** button to return to the app screen.

Note:
To remove or display the databox, selecting **Hide** or **Show** from the pop-over menu.

Data items

The following data items can be displayed in Databoxes.

Category	Data item
Battery <ul style="list-style-type: none"> • Battery 1 • Battery 2 • Battery 3 	<ul style="list-style-type: none"> • TTZ (Time To Zero) • SOC (State of Charge) • Batt. Temp. • Batt. Voltage • Batt. Current
Boat	<ul style="list-style-type: none"> • Fresh water 1 • Fresh water 2 • Live well 1 • Live well 2 • Gray water • Black water
Depth	<ul style="list-style-type: none"> • Depth
Display	<ul style="list-style-type: none"> • Supply voltage
Distance	<ul style="list-style-type: none"> • Trip season • Trip month • Trip day • Ground log
Engine <ul style="list-style-type: none"> • Port engine • Starboard engine • All engines 	<ul style="list-style-type: none"> • Engine load • RPM (Revolutions per minute) • Boost Pres. • Oil Temp. • Oil Pres. • Alternator • Coolant Pres. • Coolant Temp. • Engine trip hours • Engine hours • Fuel flow • Fuel flow (Inst)

Category	Data item
	<ul style="list-style-type: none"> • Fuel rate (Avg) • Fuel Pres. • Gear • Trans. Oil Pres. • Trans. Oil Temp.
Fuel <ul style="list-style-type: none"> • Tank 1 • Tank 2 • All Tanks 	<ul style="list-style-type: none"> • Engine economy total • Fuel flow total • Time to empty • Distance to empty • Fuel used (season) • Fuel used (trip) • Est. fuel remaining • Total fuel • Fuel level
Environment	<ul style="list-style-type: none"> • Max. water Temp. • Min water Temp. • Water Temp • Water / Voltage • Sunrise / Sunset
GPS	<ul style="list-style-type: none"> • COG (Course Over Ground) • Avg SOG (Speed Over Ground) • Max SOG • SOG • Position • COG SOG
Heading	<ul style="list-style-type: none"> • Heading
Navigation	<ul style="list-style-type: none"> • Rte ETA (Route Estimated Time of Arrival) • Rte TTG (Route Time To Go) • Wpt (Waypoint) • Wpt TTG • Wpt ETA • DTW (Distance To Waypoint) • XTE (Cross Track Error) • BTW (Bearing To Waypoint) • Waypoint info
Time	<ul style="list-style-type: none"> • Local Time • Local Date • Time and Timer



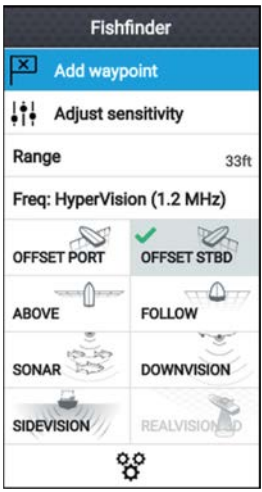
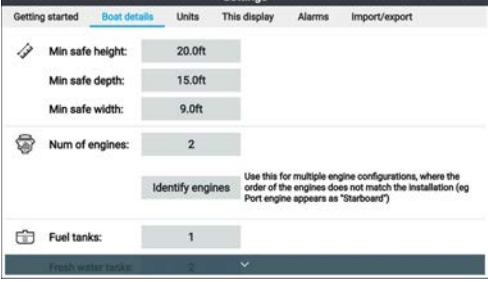
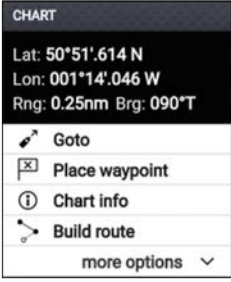
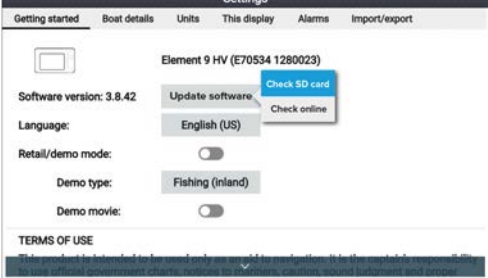

3.3 Menu types

The different types of menu available in LightHouse™ Sport are shown below.

	<h4>App menus</h4> <ul style="list-style-type: none"> • Each app includes a menu. Menus provide access to the app's features and settings. • The menu is displayed on the right side of the screen when the Menu button is pressed. • From a single app page, pressing the Back button or the Menu button will close the app menu. • From a multi-app splitscreen page, pressing the Back button will close the app menu and return to the multi-app page view. • From a multi-app splitscreen page, pressing the Menu button will close the app menu, maintaining the app in fullscreen page view. • Menu options that include a '>' symbol will open a menu page or related menu options for that item.
	<h4>Menu pages and tabs</h4> <ul style="list-style-type: none"> • Menu pages are accessed from app menu options and icons on the homescreen. • Menu pages are fullscreen pages containing menu options and settings, menu pages are usually set out in tabs with each tab containing options relevant to the tab's title. • Selecting tab titles will display the contents for that tab. • Pressing the Back button will return you to the previous menu.
	<h4>Context menus</h4> <ul style="list-style-type: none"> • Context menus are available in the Chart and Fishfinder apps. Context menus are accessed by highlighting an object or location on the app screen and pressing the OK button. • Context menus provide context sensitive information and options. • Selecting more options will display further contextual menu options. • Pressing the Back button or the Menu button will close context menus.
	<h4>Pop-over menus</h4> <ul style="list-style-type: none"> • Pop-over menus are available on the homescreen, in apps and from menu pages. Pop-over options provide access to further menu options and settings. • Pressing the Back button will close context menus.

Controls and settings

Common menu controls and options are detailed below.

	<p>Toggle switch</p> <ul style="list-style-type: none"> • Toggle switches are used to enable (switch on) or disable (switch off) various features and settings.
	<ul style="list-style-type: none"> • When enabled (switched on) the white circle will be moved right and the switch's background will be filled Green.
	<p>Setting field</p> <p>Setting fields show the selected value for that control. Selecting a setting field will display the available options relevant to the options available. Depending on field selected the options could be in the following formats:</p> <ul style="list-style-type: none"> • Pop-over options (selection list) • Numeric value control (as shown) • Onscreen keyboard • File browser • Selection list (full page)
	<p>Setting button</p> <ul style="list-style-type: none"> • Setting buttons are available on Menu pages and Notification / Alarm messages to access further settings or confirm setting changes.
	<p>Page down</p> <ul style="list-style-type: none"> • Further options are available off screen. • Scroll Down to display these options.

Chapter 4: Set up

Chapter contents

- [4.1 Display controls on page 24](#)
- [4.2 Getting started on page 26](#)
- [4.3 Shortcuts on page 29](#)
- [4.4 Memory card compatibility on page 31](#)
- [4.5 Software updates on page 33](#)
- [4.6 User data import and export on page 36](#)
- [4.7 EV-1 heading sensor on page 37](#)

4.1 Display controls

The buttons available on Element™ displays and their function are detailed below.

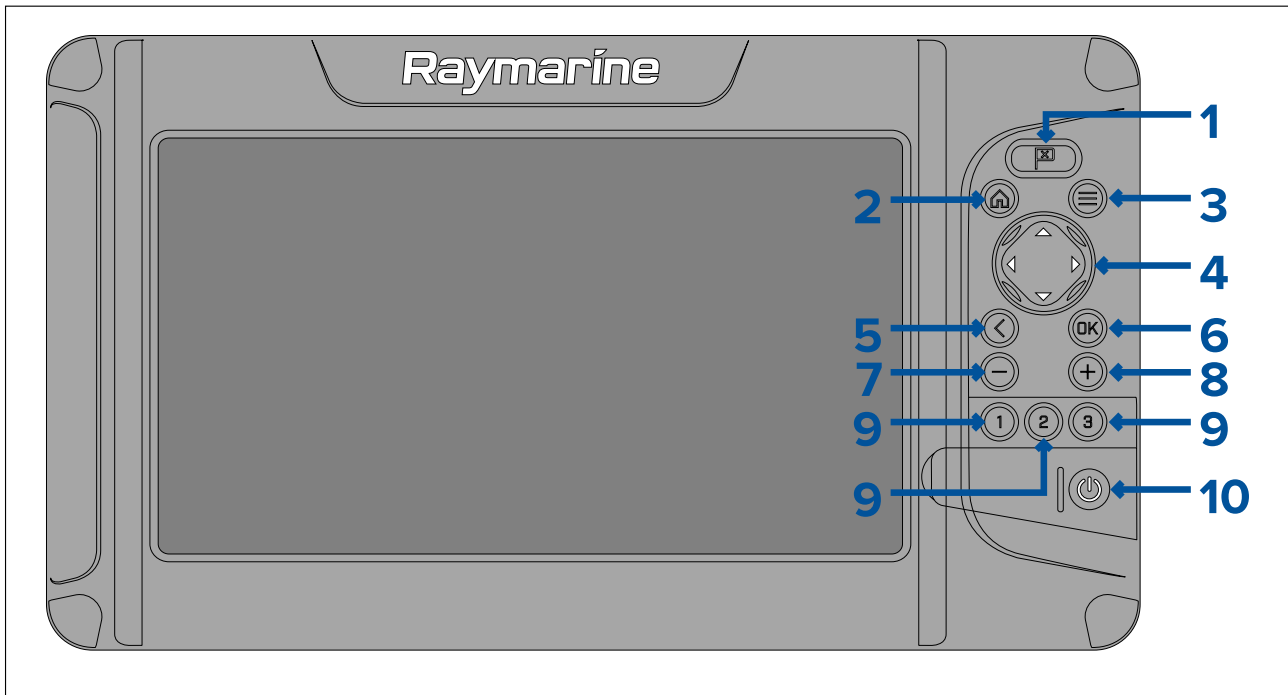

1. **Waypoint**

- Press to place a waypoint at your vessel's position (unless cursor mode is active in the Chart or Fishfinder app).
- Press to place a waypoint at the cursor's position in the Chart and Fishfinder apps (when in cursor mode).

2. **Home**

- Press to display the Homescreen.

3. **Menu**

- Press to open Homescreen menus and app menus.
- Press and hold for approximately 2 seconds to switch which app has focus in a multi app page.
- Press to close Homescreen menus and app menus.

4. **Directional pad** (8-axis directional controls)

- Use to navigate Homescreen and menus.
- Press any direction to activate cursor mode in the Chart and Fishfinder apps.
- Use to position the cursor in the Chart and Fishfinder apps.

5. **Back**

- Return to previous menu or dialog.

6. **OK** — Confirms menu selections, opens context menus

- Press to confirm a currently highlighted option.
- Press to open context sensitive menus in the Chart and Fishfinder apps.

7. **Minus** (Zoom / Range out)

- Press to increase the area displayed onscreen in the Chart app.
- Press to decrease the zoom level in the Fishfinder app, when in Zoom mode.
- Press to revert to scrolling mode from lowest zoom level in the Fishfinder app.

8. **Plus** (Zoom / Range in)

- Press to decrease the area displayed onscreen in the Chart app.
- Press once to initiate Zoom mode in the Fishfinder app, subsequent presses will increase the zoom level.

9. **Quicklaunch 1 / Quicklaunch 2 / Quicklaunch 3**

- Press to open the assigned app page.
- Press and hold to assign the quick launch button to the app page currently highlighted on the Homescreen.

10. Power

- Power on — Press and hold until the display beeps (approximately 2 seconds).
- Shortcuts menu — Press once to open the shortcuts menu.
- Power off — Press and hold until the display turns off (approximately 5 seconds).
- Power off — Press to open the Shortcuts menu and then select **Power down display**.

Switching on and off at the breaker

When powered off the display will still consume a small amount of power.

If you wish to ensure that the display is not consuming any power then it must be switched off at the breaker or have the power cable unplugged.

When the breaker is switched back on or the power cable is reconnected the display will remain powered off, until switched back on using the **Power** button.

Switching active app

On app pages that contain more than 1 app you can select which app has the current focus (i.e.: which app responds to your control).

Press and hold the **Menu** button to move focus to the next app.

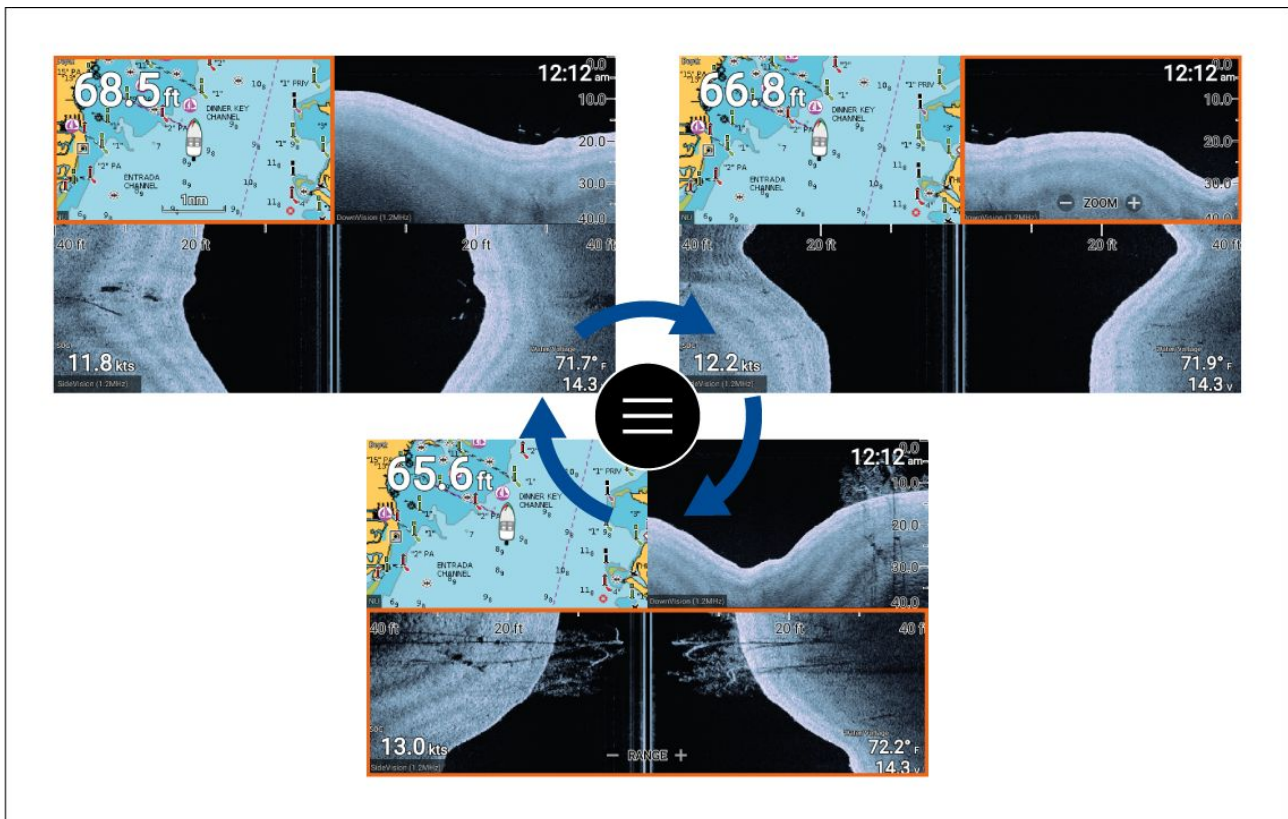

In addition to pressing and holding on the **Menu** button you can also switch app focus from the app menu. With a multi app page displayed:

1. Press the **Menu** button.
2. Highlight the **Switch to** option.
3. In app pages with more than 2 apps, use the **Right** and **Left** buttons to highlight the app you want to make active.
4. Press the **OK** button.
5. Press the **Back** button to close the menu.

4.2 Getting started

Startup wizard

The first time the display is powered up, or after a **Factory reset** the Startup wizard is displayed. The Startup wizard helps you to configure the following display settings:

- User interface language
- Boating activity
- Boat details (including: Safety clearances, Number of engines, Number of tanks, Number of batteries and Transducer selection.)

Follow the onscreen instructions to configure the relevant settings.

Important:

Ensure you select the correct type of transducer, an incorrect selection will require a factory reset to correct.

First power up Limitation on Use acknowledgement

After you have completed the Startup wizard the Limitation on Use (LoU) disclaimer is displayed.

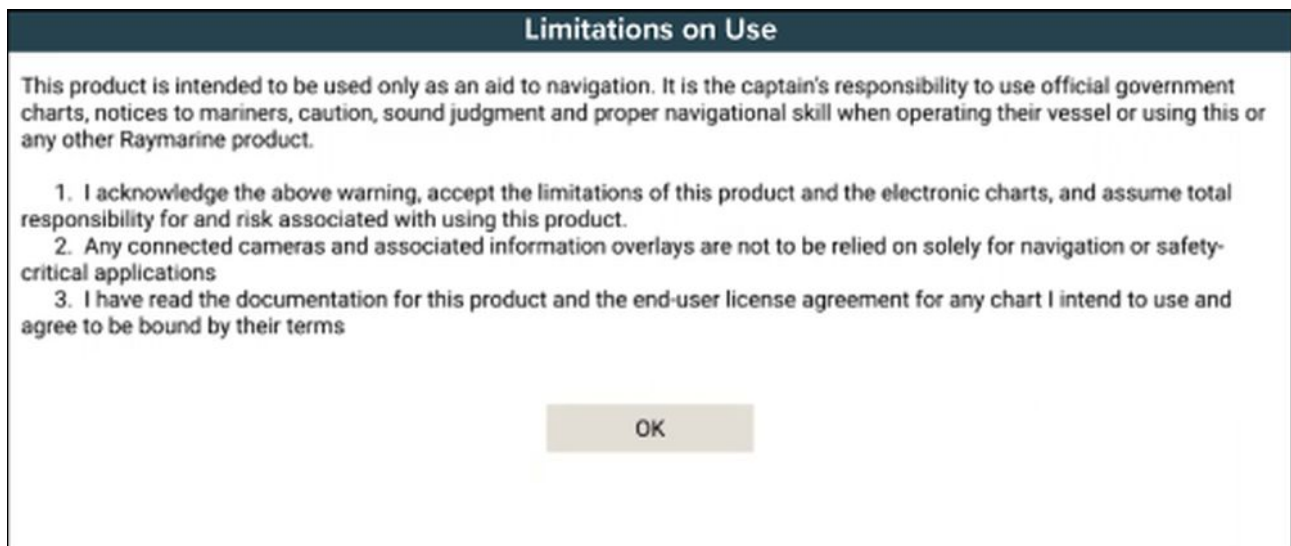

You must read and agree to the terms in order to use your display.

Selecting **OK** means you have accepted the terms of use.

Configuring transducer settings

For systems set up with a transducer connected, as part of setting up your system for the first time it is important that you correctly set up your transducer.

Transducer configuration settings are available from the **Fishfinder app**.

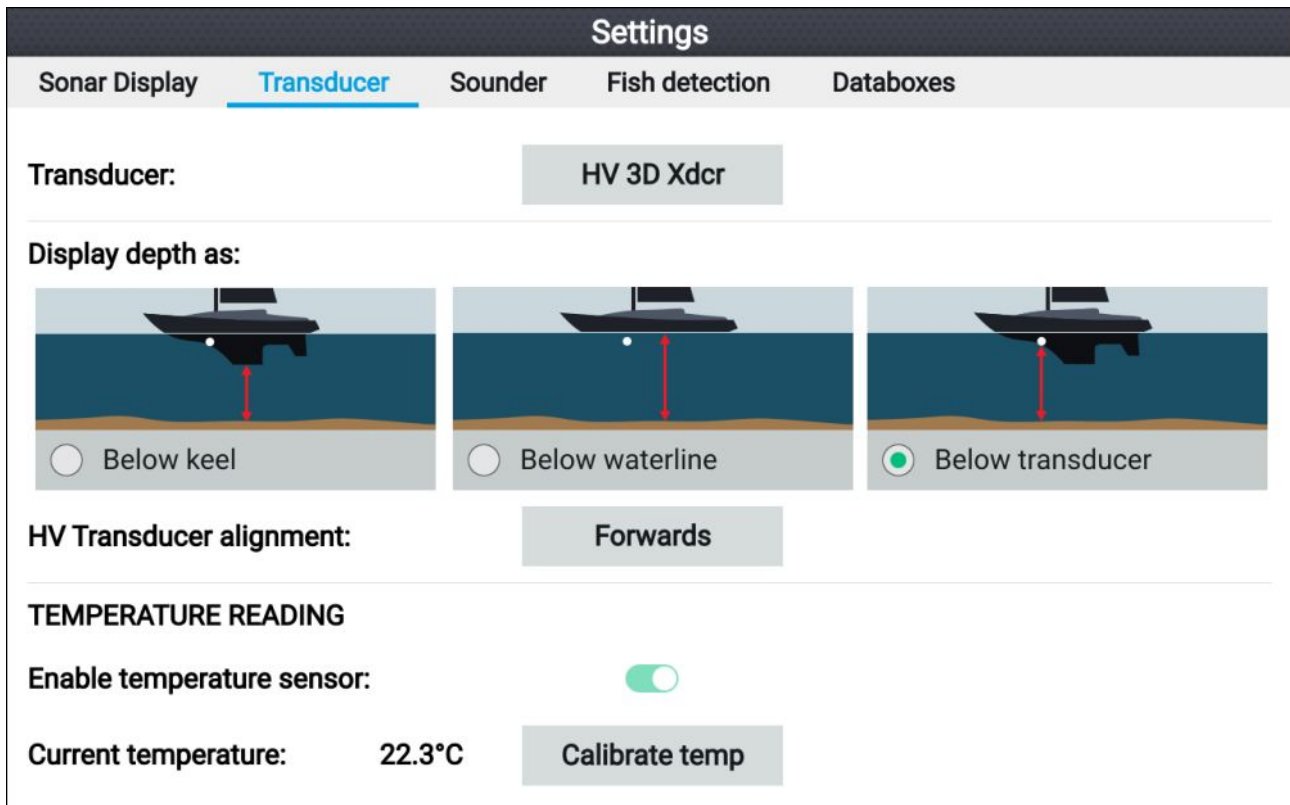

1. Select **Transducer** from the Fishfinder app's **Settings** menu: **Menu > Settings > Transducer**
2. If your installation required you to install an all-in-one transducer backwards (e.g.: this may occur when connecting the transducer to a trolling motor), then select **Backwards** from the **HV transducer alignment** option. This ensures that the port and starboard channels appear correctly orientated onscreen, otherwise keep the default setting: **Forwards**.
3. Select where you want your depth measurements taken from:
 - i. Below transducer (default) — No offset required
 - ii. Below keel — Enter the distance between the transducer face and the bottom of the keel.
 - iii. Below waterline — Enter the distance between the bottom of your keel and the waterline.
4. You can configure temperature settings as follows:
 - i. Enable or disable temperature readings as required.
 - ii. If enabled, check the temperature reading against the actual water temperature.
 - iii. If the current reading requires adjustment, select **Calibrate temp** and enter the difference between your 2 readings.

Identifying engines

Engine data can be shown on your display, if your engines are transmitting the relevant supported data on the same network as your display. If your system has mislabelled your engines then you can correct this using the Engine identification wizard.

The Engine identification wizard can be accessed from the Boat details menu: **Homescreen > Settings > Boat details > Identify engines**.

1. Ensure the correct number of engines is selected in the **Num of Engines:** box.
2. Select **Identify engines**.
3. Follow the onscreen prompts to complete the engine identification wizard.

Performing a settings or factory reset

Performing a **Factory reset** will erase ALL user data and reset the display's settings to their Factory default values. Performing a **Settings reset** will restore your display's settings to factory defaults, whilst retaining user data.

1. Select **Settings reset**, from the **This display** menu: **Homescreen > Settings > This display > Settings reset** to perform a settings reset.
2. Select **Factory reset**, from the **This display** menu: **Homescreen > Settings > This display > Factory reset** to perform a factory reset.

Importing user data

You can import user data (i.e.: GPX format Waypoints, Routes and Tracks) to your display.

1. Insert the MicroSD card that contains your user data files into the memory card reader on your display.
2. Select **Import from card** from the Import/export menu: (**Homescreen > Settings > Import/export > Import from card**).
3. Navigate to your User data file (.gpx).
4. Select the relevant GPX file.
Your user data has now been imported.
5. Select **OK**.

4.3 Shortcuts

The Shortcuts menu can be accessed by pressing the **Power** button.

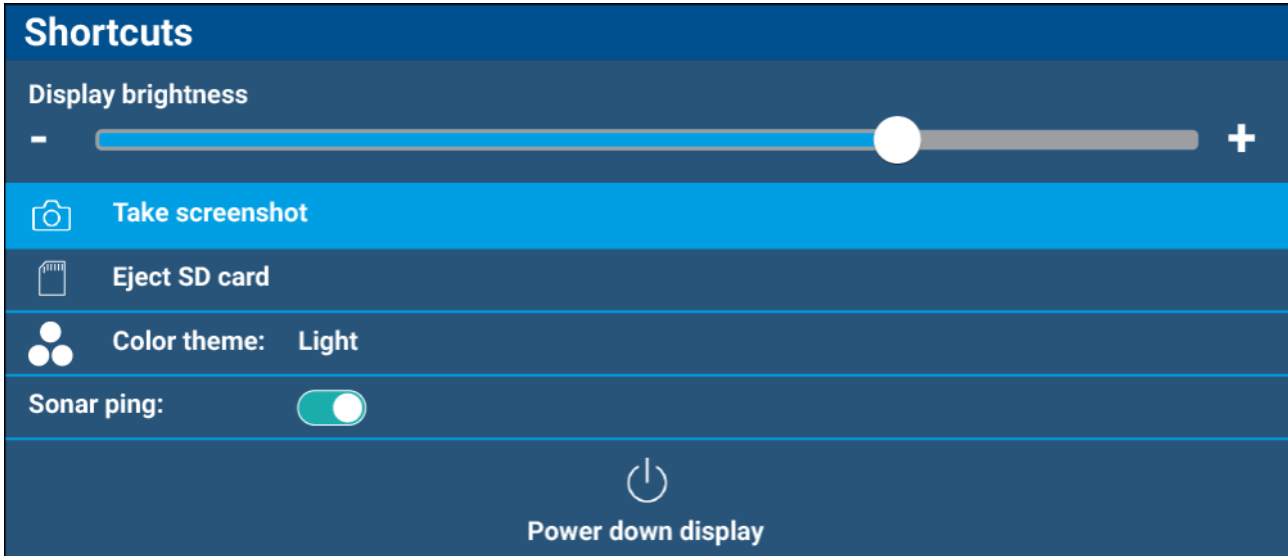

The following shortcuts are available:

- **Display brightness**
- **Take Screenshot**
- **Eject SD card**
- **Color theme**
- **Sonar ping**
- **Power down display**

Note:

If no controls are pressed, the **Shortcuts** menu will automatically close after approximately 5 seconds

Taking a screenshot

You can take a screenshot and save the image to external memory.

1. Insert a memory card into the card reader slot.
2. Press the **Power** button.
The Shortcuts menu is displayed.
3. Select **Take screenshot**.

The screenshot will be saved in .png format to the inserted memory card.

Adjusting brightness

Display brightness (backlight illumination level) can be adjusted from the **Shortcuts** menu. Lower brightness levels are recommended for viewing the display during low light conditions (e.g.: at night) and higher levels for daylight viewing. Lower brightness levels will also help to preserve battery power.

With the Shortcuts menu displayed (accessible via the Power button):

1. Use the **Plus** and **Minus** buttons or the **Left** and **Right** buttons to adjust display brightness.

Note:

When the brightness is not set to maximum and the shortcuts menu is displayed, each press of the **Power** button will increment the brightness level.

Changing the display's color theme

You can change the color theme of your display's user interface from the **Shortcuts** menu.

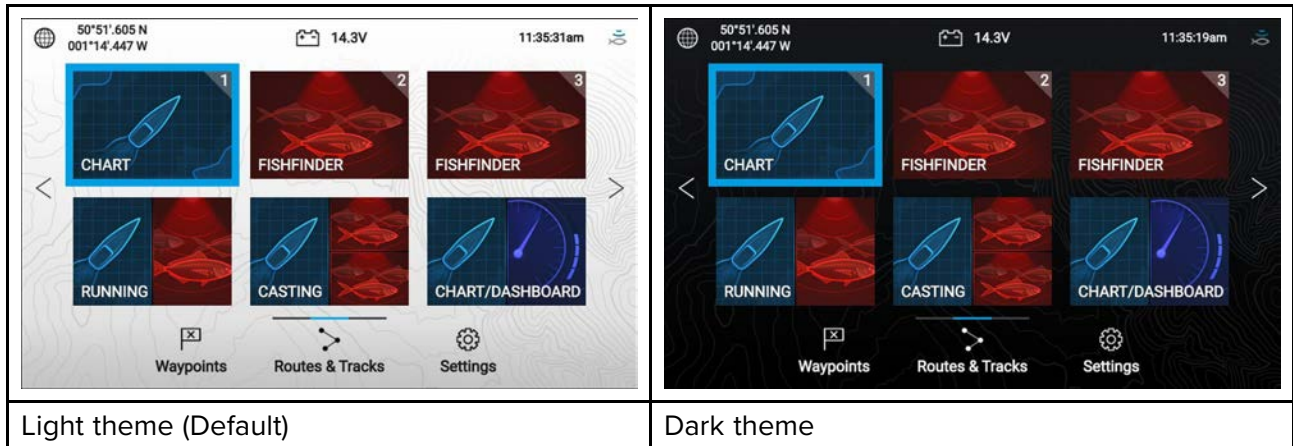

With the Shortcuts menu displayed (accessible via the Power button):

1. Select **Color theme:**
The pop-over menu with available color themes is displayed.
2. Select the desired color theme.

Note:

Changing the **Color theme** inverts the Black and White colors used for text and in Homescreen and menu backgrounds. The dark theme is recommended in lower light conditions e.g.: at night.

Disabling and enabling sonar ping

You can disable and enable your sonar module ping from the **Shortcuts** menu.

With the Shortcuts menu displayed (accessible via the Power button):

1. Select **Sonar ping:** to disable or enable sonar pinging.

4.4 Memory card compatibility

MicroSD memory cards can be used to backup / archive data (e.g. Waypoints, Routes and Tracks). Once data is backed up to a memory card, old data can be deleted from the system. The archived data can be retrieved at any time. It is recommended that your data is backed up to a memory card on a regular basis.

Compatible cards

The following types of MicroSD cards are compatible with your MFD:

Type	Size	Native card format	MFD supported Format
MicroSDSC (Micro Secure Digital Standard Capacity)	Up to 4GB	FAT12, FAT16 or FAT16B	NTFS, FAT32
MicroSDHC (Micro Secure Digital High Capacity)	4GB to 32GB	FAT32	NTFS, FAT32
MicroSDXC (Micro Secure Digital eXtended Capacity)	32GB to 2TB	exFAT	NTFS, FAT32

- **Speed class rating** — For best performance it is recommended that you use Class 10 or UHS (Ultra High Speed) class memory cards, or better.
- **Use branded memory cards** — When archiving data it is recommended that you use good quality branded memory cards.

Removing MicroSD card from its adaptor

MicroSD memory and cartography chart cards are usually supplied inserted into an SD card adaptor. The card will need to be removed from the adaptor before inserting into your display.

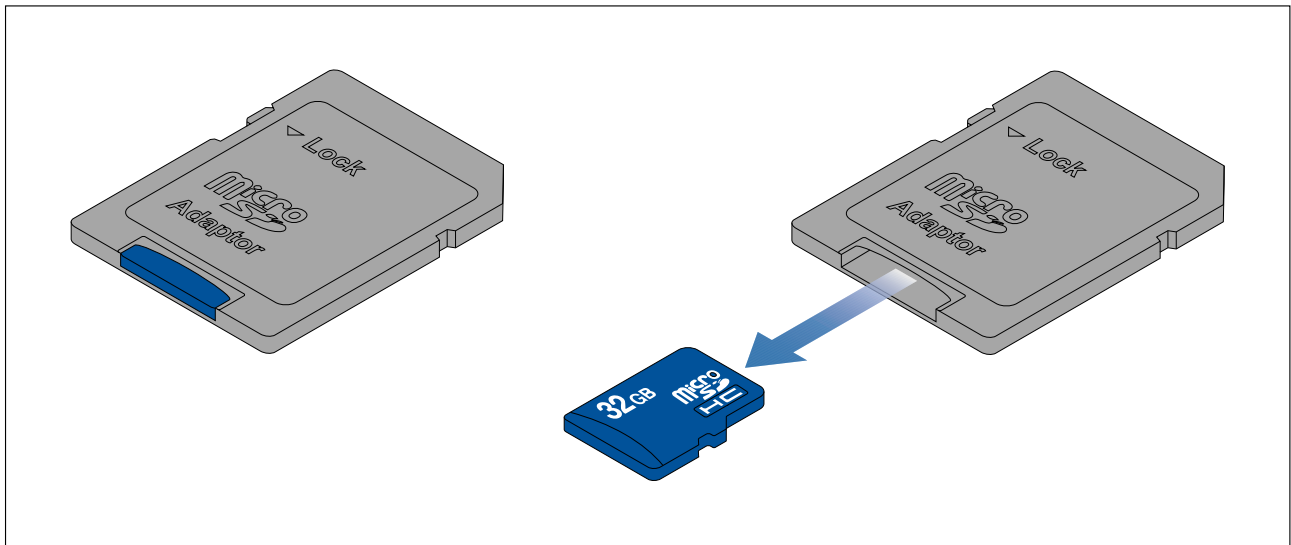

Inserting a MicroSD card

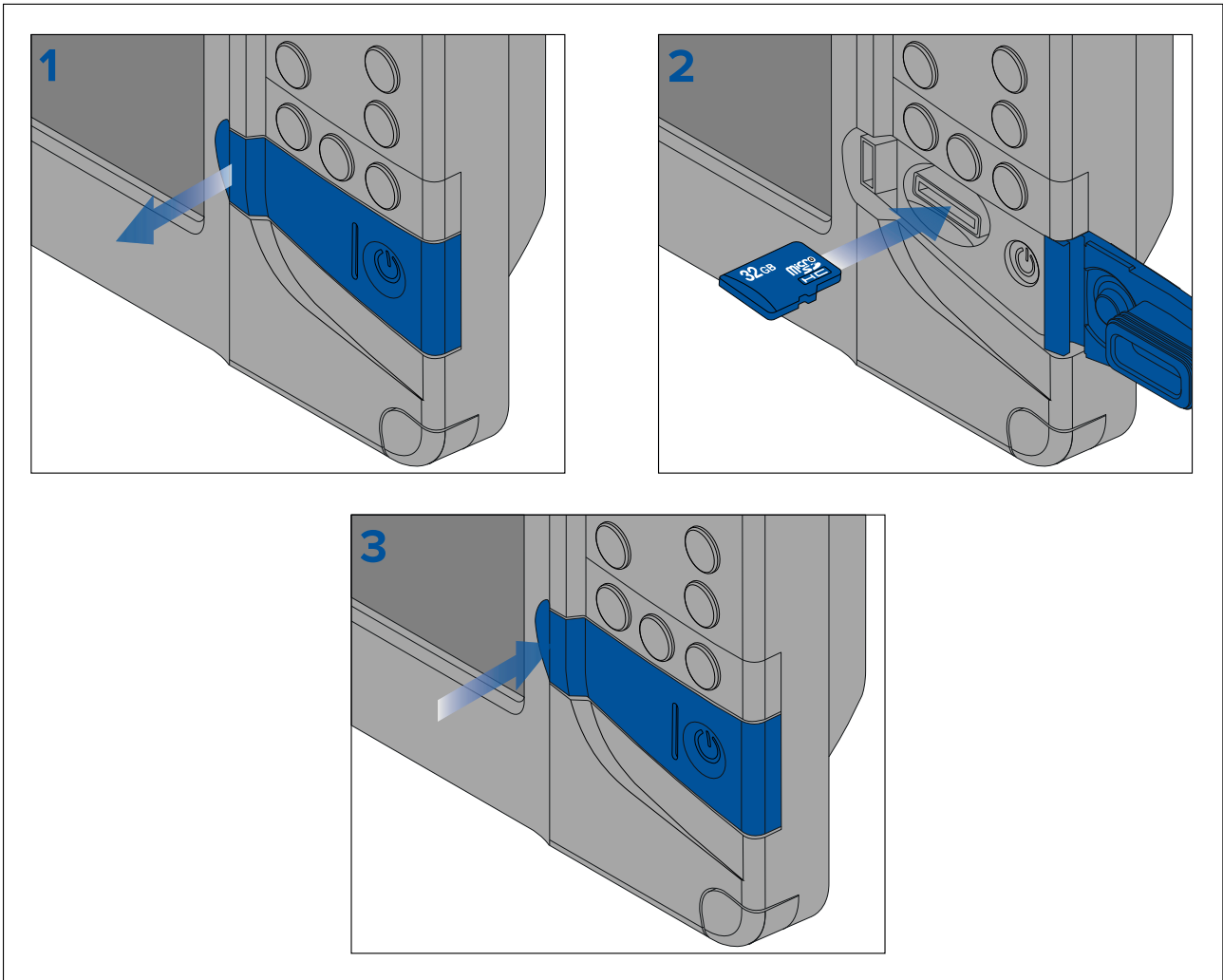

1. Open the card reader door.
2. Ensuring correct orientation (contacts facing down), insert the MicroSD card into the card reader slot.
3. Close the card reader door, ensuring that the edges of the door are flush.

Removing the MicroSD card

1. Press the **Power** button.
The **Shortcuts** menu is displayed.
2. Select **Eject SD card**.
3. Open the card reader door.
4. Remove the MicroSD card from the Rear of the MFD.
5. Close the card reader door.
6. Select **OK** on the confirmation dialog.

Caution: Ensure card reader cover or door is securely closed

To prevent water ingress and consequent damage to the product, ensure that the card reader door or cover is firmly closed.

4.5 Software updates

Raymarine® regularly issues software updates for its products which provide new and enhanced features and improved performance and usability.

It is important to ensure that you have the latest software for your products by regularly checking the Raymarine® website for new software releases.

www.raymarine.com/software

Note:

- It is recommended that you always backup your User data before performing a software update.
- The “Check online” feature is only available when the display has an active Internet connection.

In addition to updating your display’s software, your display can also be used to update the software of devices connected to the same SeaTalkng® backbone.

The following devices are currently approved for updating using an Element™ display:

- EV-1 heading sensor
- ECI-100 engine gateway
- i70s Multifunction instrument display
- p70s / p70Rs pilot controller

Identify display variant and software version

Refer to the Getting started menu: **Homescreen > Settings > Getting started** on your display to identify product variant and current software version.

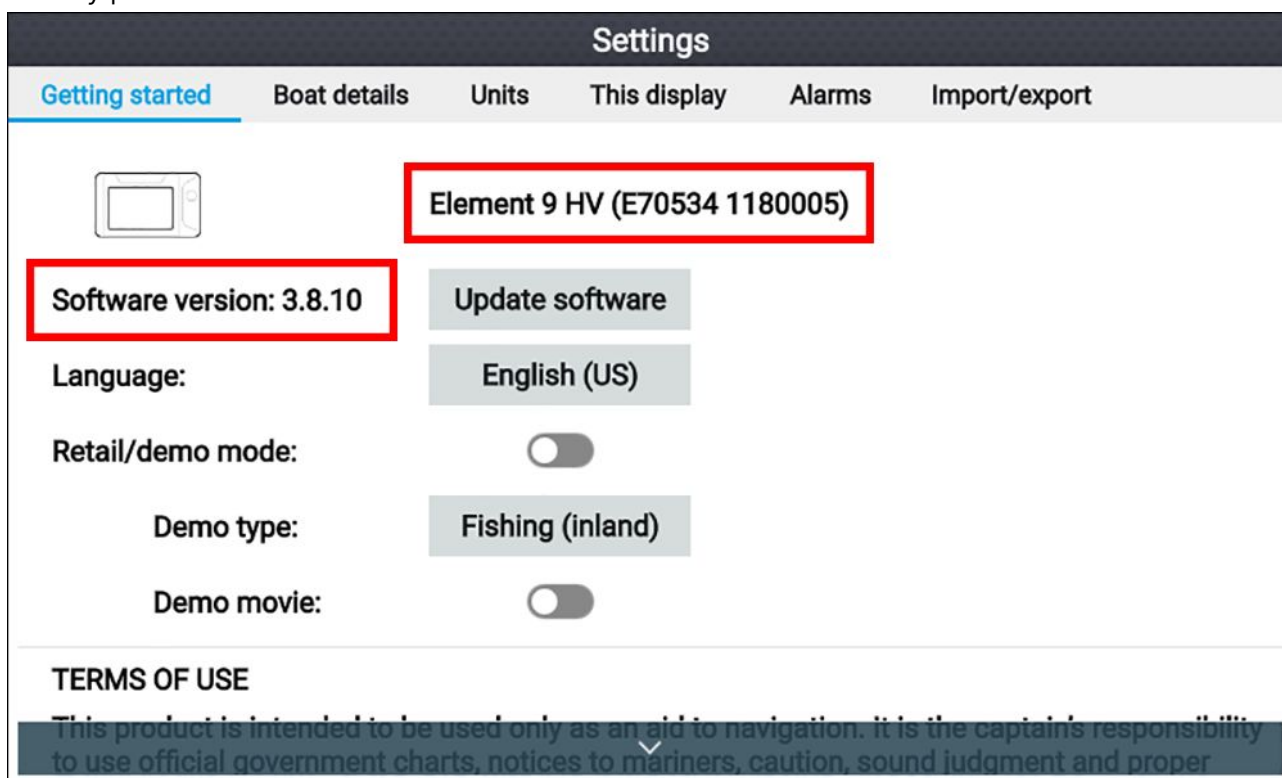

Identifying software versions of connected products

To identify the software version of products connected to the same SeaTalkng® backbone follow the steps below.

From the Homescreen:

1. Select **Settings**.
2. Select the **This display** tab.
3. Select **Product info**.

Product information will be displayed for your display and for compatible product connected to the same SeaTalkng® backbone. The software version is list against **Application version**:

4. If required, use the **Up** and **Down** buttons to scroll the list of available product information.

5. You can also save the list of product information to memory card by selecting **Save data**.

The product information file will be saved in .json file format that can be viewed using most standard notepad applications.

Updating display software using a memory card

Follow the steps below to update the software on your display.

1. Check the product hardware variant and the software version of the products you want to update.
2. Go to the Raymarine website: (www.raymarine.com > **Support** > **Software Updates**).
3. Browse for your product.
4. Check if an updated software version is available for your product.
5. Download the relevant software package(s) (ISO files).
6. Copy the files to MicroSD card.
7. With your display powered on, insert the MicroSD card into the card reader slot.

The software update files will be recognized automatically.



8. Select **Yes** to update the software.

A list of available products is displayed. The list will include your display and products that are connected to the SeaTalkng[®] backbone.

Software update list example

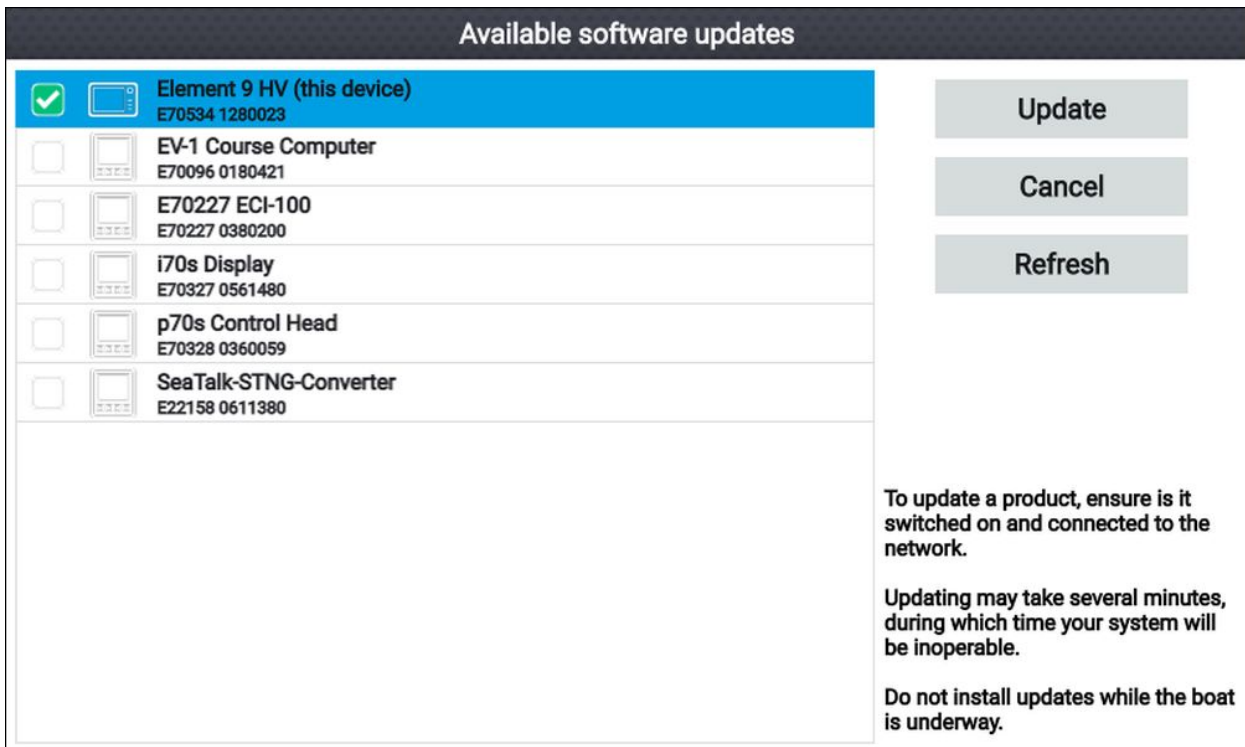

9. Select each device that you want to update.

*If a notification is displayed asking if you want to reinstall the current software version, unless you are experiencing problems with the product select **No**, otherwise select **Yes** and the current version of software will be reinstalled.*

10. When all relevant products have been chosen, select **Update selected** to commence the software update process.
11. Wait for the update process to complete.
12. Select **Exit**.

Note:

- Your products may reboot automatically as part of the update process.
- You can also select **Check SD card** from the **Update software** pop-over options (**Homescreen > Settings > Getting started > Update software**).

Updating software using an internet connection

Follow the steps below to update your display's software and software on approved devices connected to the same SeaTalkng[®] backbone, using an internet connection.

1. Select **Update software** from the Getting started menu: (**Homescreen > Settings > Getting started**).

2. Select **Check online** from the pop-over menu.

If you do not have an active internet connection then you will be requested to create one.

3. To set up a Wi-Fi connection select **Wi-Fi settings** and connect to the required Wi-Fi access point/hotspot.

4. Select **Start**.

A list of available products is displayed. The list will include your display and products that are connected to the SeaTalkng[®] backbone.

Software update list example

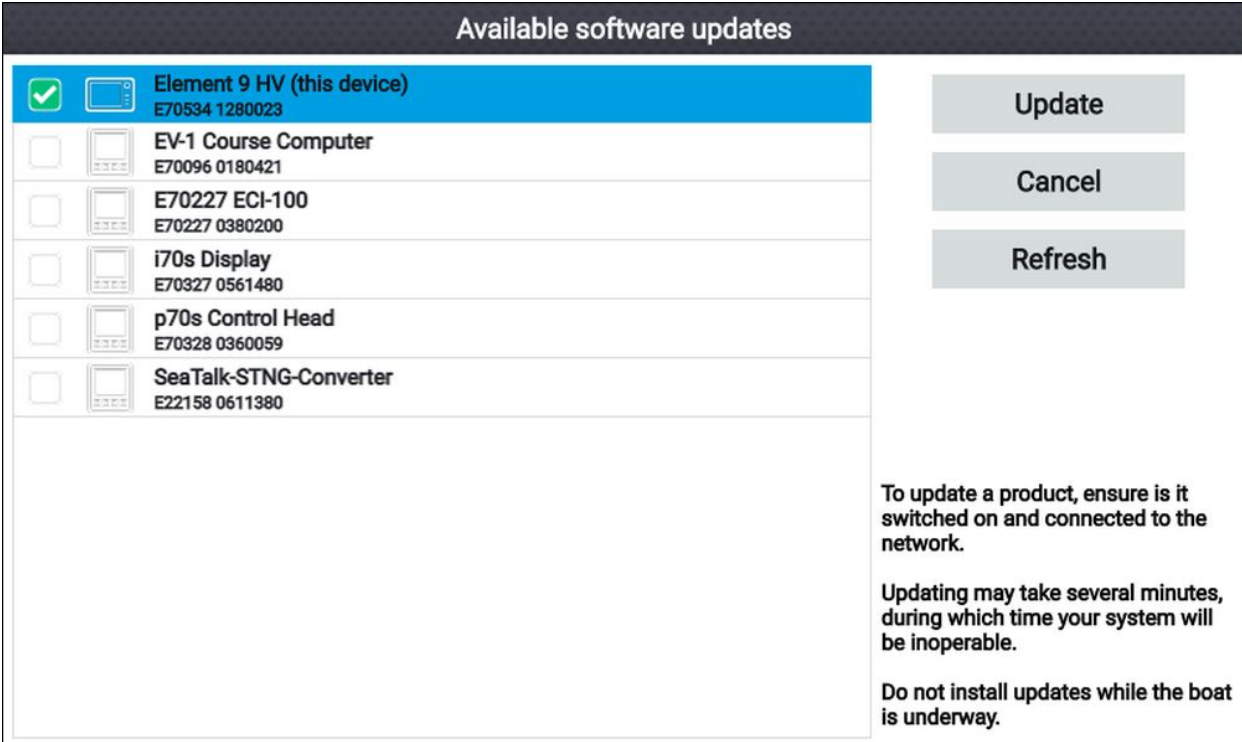

Available software updates	
<input checked="" type="checkbox"/>	Element 9 HV (this device) E70534 1280023
<input type="checkbox"/>	EV-1 Course Computer E70096 0180421
<input type="checkbox"/>	E70227 ECI-100 E70227 0380200
<input type="checkbox"/>	i70s Display E70327 0561480
<input type="checkbox"/>	p70s Control Head E70328 0360059
<input type="checkbox"/>	SeaTalk-STNG-Converter E22158 0611380

To update a product, ensure it is switched on and connected to the network.

Updating may take several minutes, during which time your system will be inoperable.

Do not install updates while the boat is underway.

5. Select each device that you want to update.

*If a notification is displayed asking if you want to reinstall the current software version, unless you are experiencing problems with the product select **No**, otherwise select **Yes** and the current version of software will be reinstalled.*

6. When all relevant products have been chosen, select **Update selected** to commence the software update process.
7. Wait for the update process to complete.
8. Select **Exit**.

Note:

Your products may reboot automatically as part of the update process.

4.6 User data import and export

User data (i.e.: Waypoint, Routes and Tracks) can be imported and exported from your display. User data is saved in the common .gpx file format.

The Import/export menu can be accessed from the homescreen settings menu **Homescreen > Settings > Import/export**.

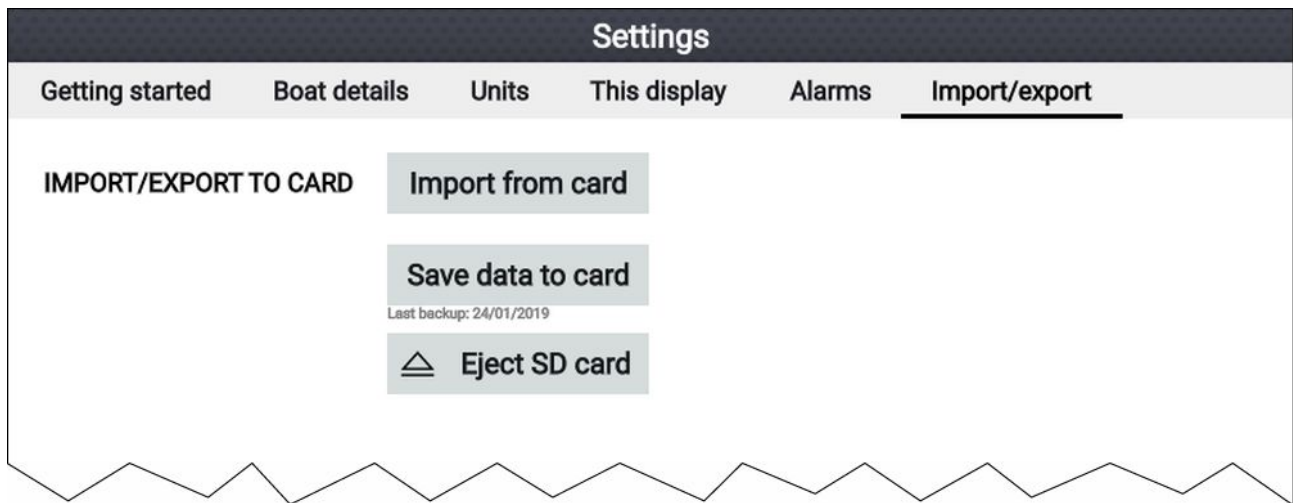

Saving user data

You can backup your user data (waypoints, routes and tracks) to a MicroSD card.

1. Insert a memory card into your display's card reader.
2. Select **Save data to card** from the Import/export menu: **Homescreen > My data > Import/export**. A pop-over menu is displayed.
3. Select the desired option:
 - **Save all data** to save (export) all waypoints, routes and tracks.
 - **Save waypoints** to save (export) all waypoints.
 - **Save routes** to save (export) all routes.
 - **Save tracks** to save (export) all tracks.
4. Select **Save** to save the user data using the default filename. Alternatively:
 - i. Use the onscreen keyboard to enter your own filename and then select **Save**.
5. Select **OK** to return to the Import/export menu, or select **Eject card** to safely remove the memory card.

The user data file is saved to the '\Raymarine\My Data\' directory of your memory card in gpx format.

Importing user data

You can import user data (i.e.: GPX format Waypoints, Routes and Tracks) to your display.

1. Insert the MicroSD card that contains your user data files into the memory card reader on your display.
2. Select **Import from card** from the Import/export menu: **(Homescreen > Settings > Import/export > Import from card)**.
3. Navigate to your User data file (.gpx).
4. Select the relevant GPX file.
Your user data has now been imported.
5. Select **OK**.

4.7 EV-1 heading sensor

You can connect an EV-1 heading sensor to your display, this will ensure that accurate heading data is available, regardless of vessel movement.

The EV-1 heading sensor will automatically calibrate (linearize) itself while the following conditions are met:

- vessel speed is between 3 to 15 knots, and
- at least a 270° turn has been made.

Note:

The time it takes for automatic calibration can be reduced by completing a full 360° turn at between 3 to 15 knots.

After the initial calibration has been completed a notification will be displayed and a Max deviation value will be reported in the **EVO COMPASS** section of the **This display** menu. If dashes are displayed then the calibration has not been successful.

If the Maximum deviation is 45° or greater, it is recommended that either the EV-1 is relocated, in a location with less magnetic interference, or that any devices causing magnetic interference are moved farther away from the EV-1.

Manually adjusting an EV-1 heading sensor

If there is a difference between Heading and the reported COG (Course Over Ground), which is not attributable to tide and wind conditions, then you can adjust the EV-1 heading sensor's settings to compensate.

The EV-1 settings can be accessed from the **This display** menu: **Homescreen > Settings > This display > EVO set-up**.

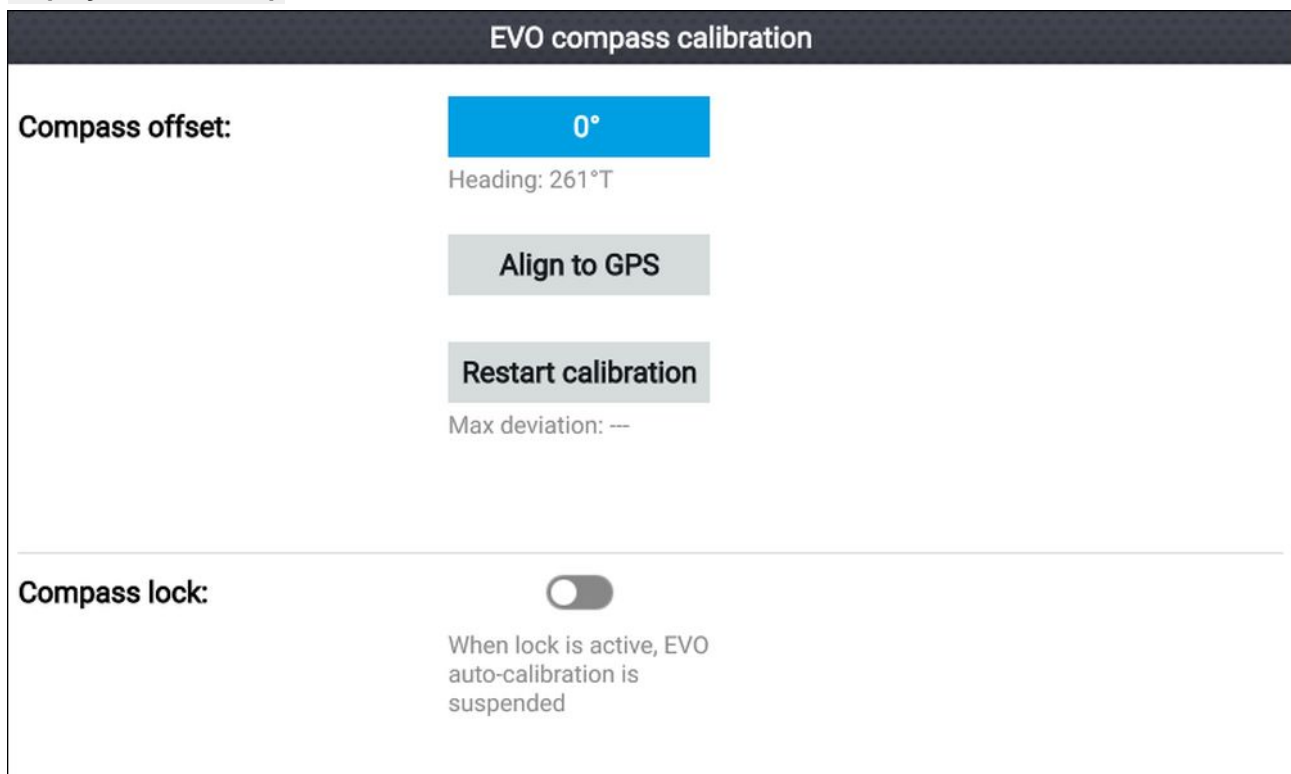

1. If the difference is within plus or minus 10°, then select the **Compass offset** field and adjust until COG and heading values are the same, or
2. If the difference is greater than plus or minus 10° you can align your heading sensor to the COG, reported by your GPS/GNSS, by selecting **Align to GPS** and following the onscreen instructions.

Restarting calibration

If you experience problems with your heading data or have had to relocate the EV-1 sensor then you can restart the automatic calibration.

From the this display menu:

1. Select **EVO set-up**.
2. Select **Restart calibration**.

The maximum deviation will be reset and automatic calibration will commence once vessel speed (3 to 15 knots) and turn circle (at least 270° turn) conditions are met.

Locking compass calibration

The EV-1 sensor is designed to continually adjust its calibration settings in the background to improve its accuracy.

If your vessel is regularly in environments with strong magnetic disturbances (e.g.: offshore wind farms or busy rivers) it may be desirable to use the compass lock feature to prevent the continual adjustment, as over time this may cause an error in reported heading.

To enable compass lock:

1. Select **EVO set-up** from the **This display** menu.
2. Select the Compass lock toggle switch so that it is enabled.

Note:

You can disable the calibration lock at anytime by disabling the **Compass lock** toggle switch.

Chapter 5: Homescreen

Chapter contents

- 5.1 Homescreen overview on page 40
- 5.2 Customizing app pages on page 43
- 5.3 Creating a new app page on page 44
- 5.4 Satellite navigation / positioning on page 45
- 5.5 Status area on page 47
- 5.6 Timer on page 47
- 5.7 Alarms on page 49
- 5.8 Settings menu on page 51

5.1 Homescreen overview

All settings and apps can be accessed from the Homescreen.

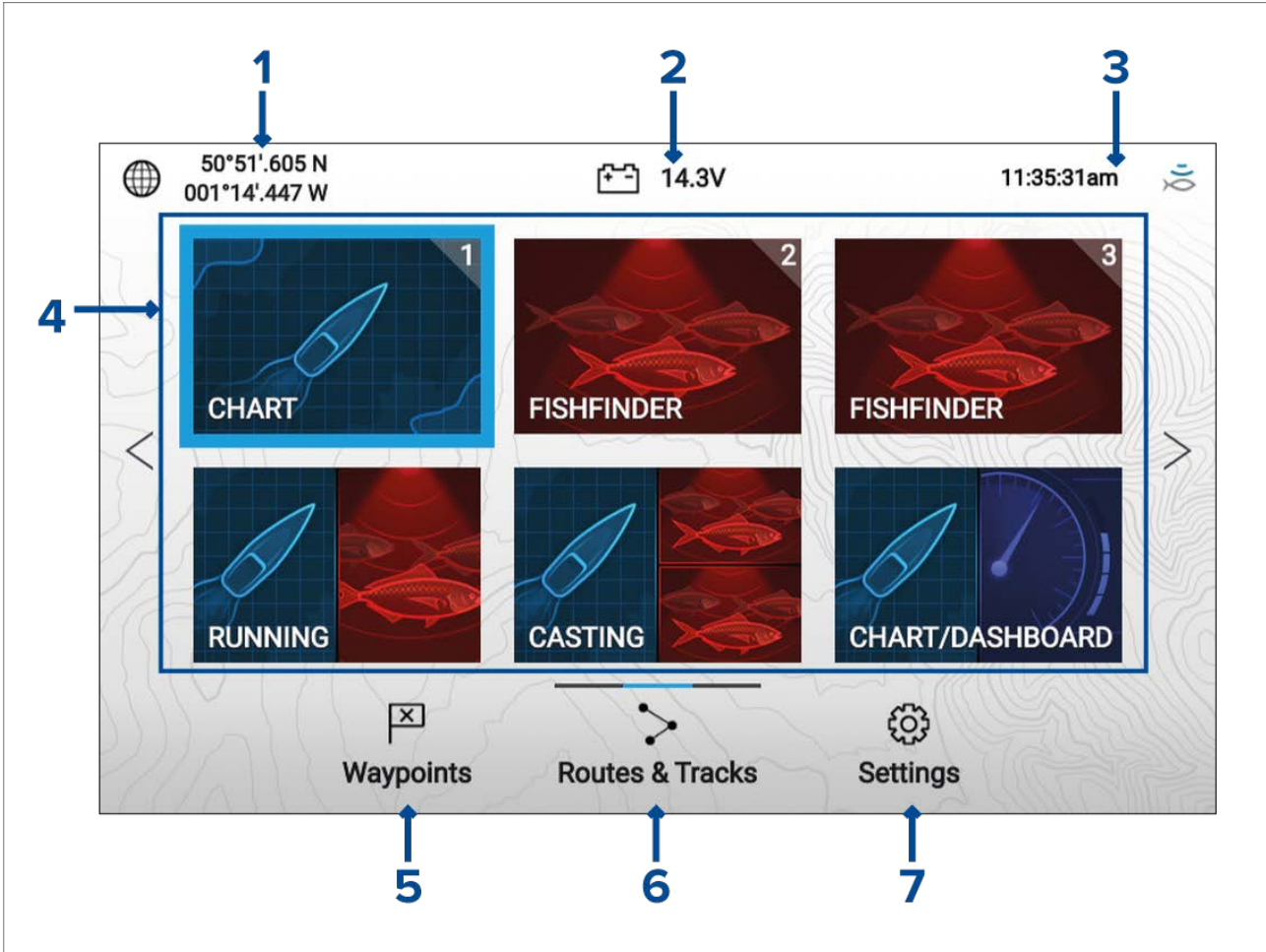

1. **Position/fix details** — Shows your vessel's current position coordinates. Select the area to view fix accuracy and to access position settings.
2. **Supply voltage** — Shows the display's supply voltage. The Voltage reading is colored Red if the current supply voltage is lower than the value specified in the **Low voltage threshold** alarm setting: **Homescreen > Settings > Alarms > Low voltage threshold:**
3. **Status area** — Displays system time, count down/up timer and sonar ping status. Select the area to set count down / up timer, time zone and to set daylight savings.
4. **App page icons** — The Homescreen is made up of 3 pages that can each contain up to 6 app page icons. Selecting an app page icon opens the relevant app page. To view a different Homescreen page, keep pressing the Directional pad's **Left** or **Right** buttons until the Homescreen page changes. You can identify which Homescreen page is being shown using the indicator bar, located above the **Routes & Tracks** icon.
5. **Waypoints** — Select to view the **Waypoints** list.
6. **Routes & Tracks** — Select to view the **Routes and Tracks** lists.
7. **Settings** — Select to view the display's **Settings** menu.

Note:

The combination of the selected **Activity** and **Transducer selection** during the Start up wizard determines the default app page icons displayed on the Homescreen.

Accepting the Limitations on Use

After your display has powered up the Homescreen is displayed.

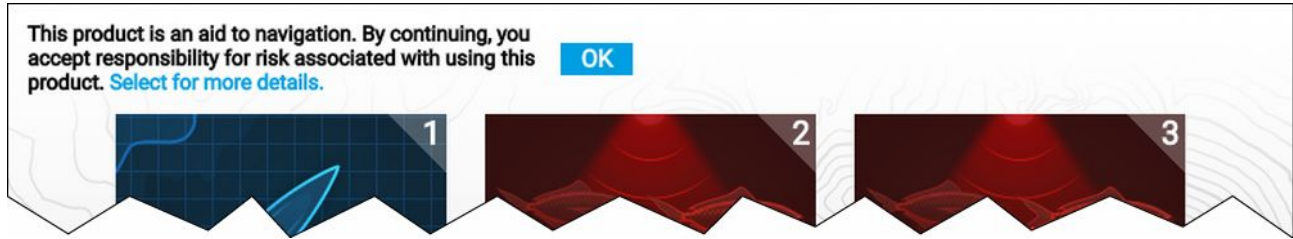

1. Before using the display you must accept the Limitations on Use (LoU) disclaimer. To view the full LoU Disclaimer, use the **Left** button to highlight the text and press the **OK** button.

*The LoU acknowledgment is displayed each time the display is powered on. The full LoU text can be accessed at any time, it is located at the bottom of the **Getting started** menu: **Homescreen > Settings > Getting started** .*

Available apps

Apps are used in App pages. Each app page is represented on the Homescreen by an app page icon. Each app page can include up to 4 apps. The individual apps available are:

<p>CHART</p>	<p>Chart — The Chart app displays electronic cartographic information from your Chart cards and when used in conjunction with a GNSS receiver, plots your vessel's position. The Chart app can be used to mark specific locations using Waypoints, build and navigate Routes or keep a record of where you have been by recording a Track.</p>
<p>FISHFINDER</p>	<p>Fishfinder — The Fishfinder app uses a connected transducer to help you find fish by creating an underwater view of bottom structure and targets in the water column that is covered by your transducer.</p>
<p>DASHBOARD</p>	<p>Dashboard — The Dashboard app provides data readings from connected sensors and equipment. The Dashboard app is also used for controlling, configured, compatible.</p>
<p>Note: The Dashboard app is only available in splitscreen app pages.</p>	

Assigning app pages to Quicklaunch buttons

App pages assigned to the Quicklaunch buttons are identified using the associated Quicklaunch button number in the top right corner of the app page icon.

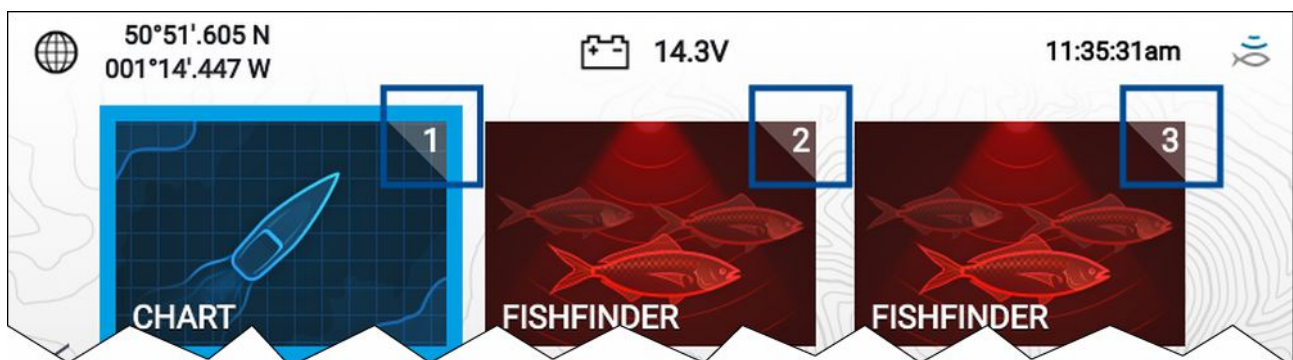

You can change which app page is assigned to the Quicklaunch buttons by following the steps below:

1. Using the **Directional pad**, highlight the app page icon that you want to assign to a Quicklaunch button.

2. Press and hold the relevant **Quicklaunch** button until the 'Quicklaunch button configured' message is displayed.

The app page icon is updated to show the associated **Quicklaunch** button number in the top right corner of the icon.

3. Repeat steps 1 and 2 for the remaining **Quicklaunch** buttons, if required.

5.2 Customizing app pages

You can customize the homescreen app pages.

1. Highlight the app page icon you want to change.

2. Press and hold the **OK**.

The pop-over menu is displayed.

3. Select the relevant option:

- **Customize** — select customize to change the app page to one of the available configurations.
- **Delete** — select delete to delete the app page icon from the homescreen.
- **Rename** — select rename to change the name of the app page icon using the onscreen keyboard.
- **Assign as Quicklaunch 1/2/3** — select to assign the app page to a Quicklaunch button.

5.3 Creating a new app page

The homescreen consists of 3 homescreen pages, the first page is populated with app page icons by default. New pre-configured app pages can be added to the homescreen.

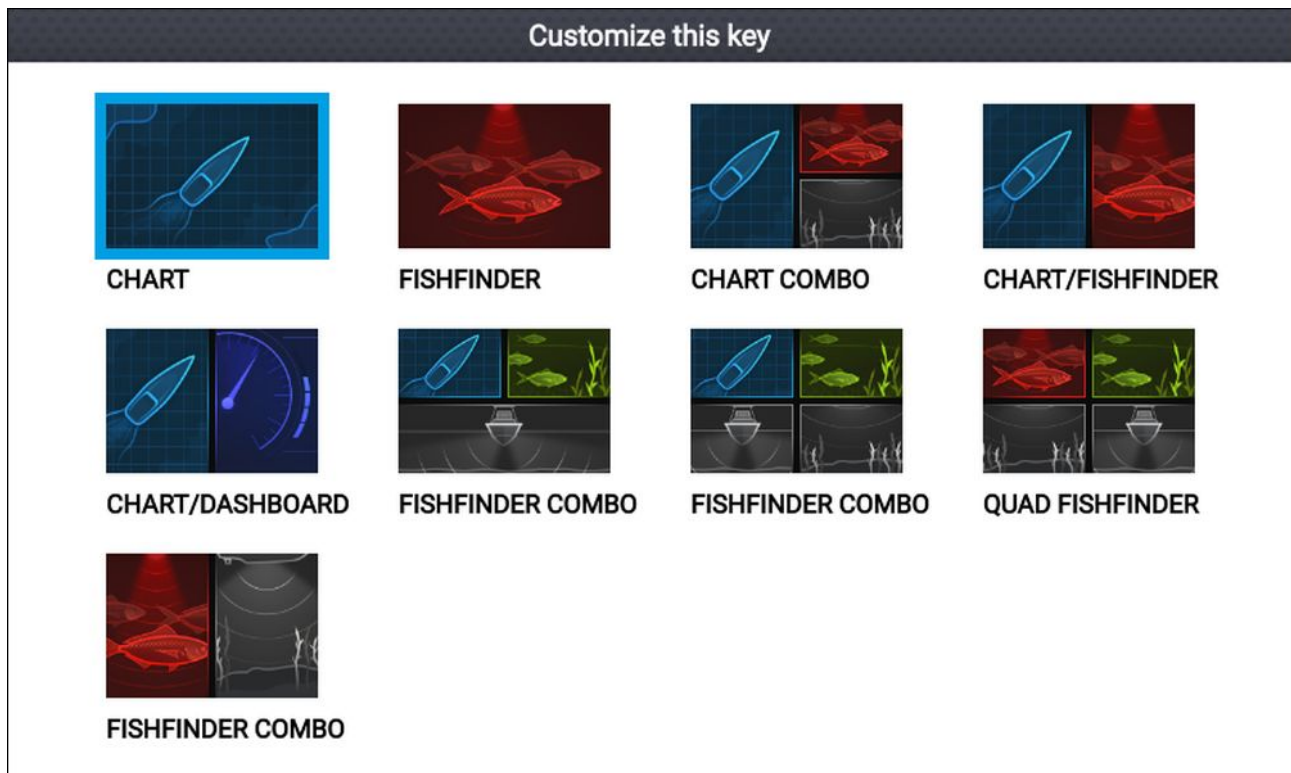

1. If required, use the **Left** and **Right** buttons to display a homescreen page that has space available.
2. Highlight a blank space on the homescreen.
3. Press and hold the **OK** button.
4. Select the desired app page configuration.

The new app page icon will now be available on the homescreen.

5.4 Satellite navigation / positioning

GPS/GNSS status

Your vessel's GPS/GNSS position coordinates are provided in the top left corner of the homescreen. You can access fix accuracy and settings by selecting this area.

If latitude and longitude is displayed on the homescreen, your vessel has a valid position fix. If the text turns red, it means that your fix accuracy is low.

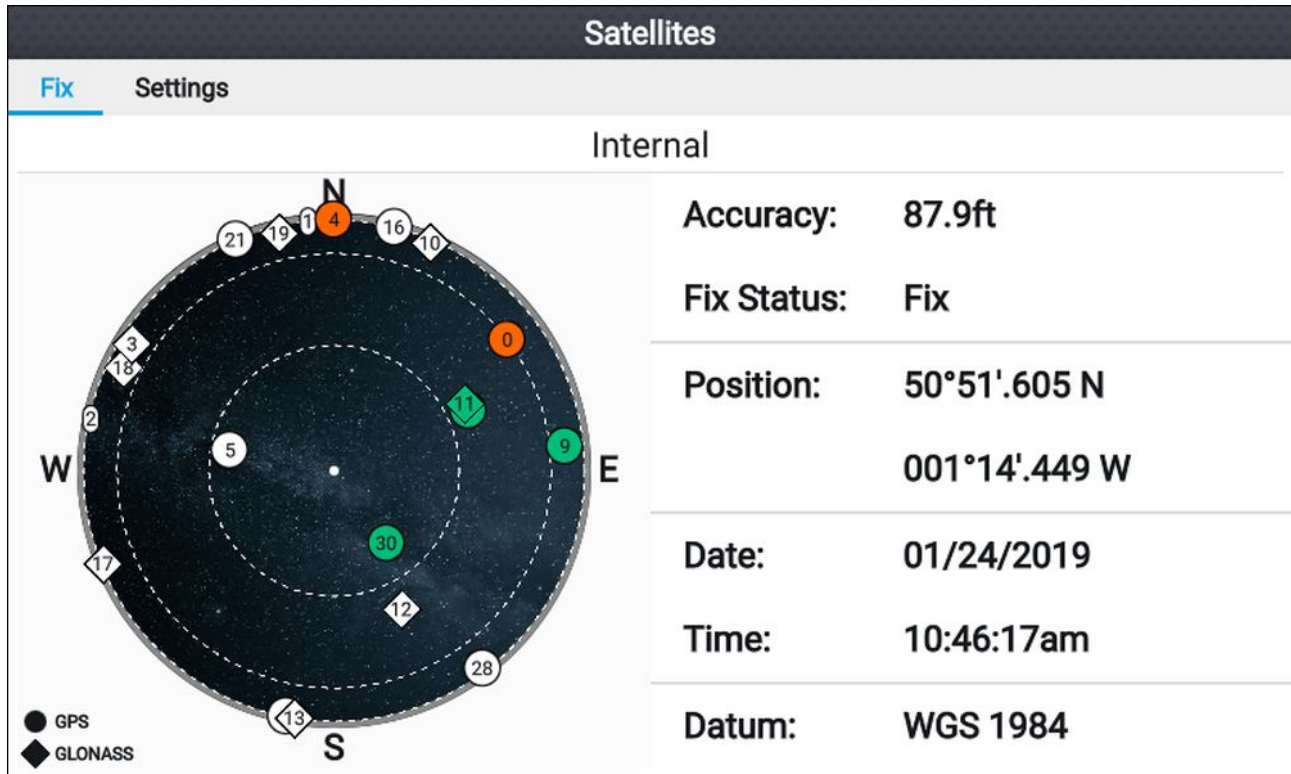

The sky view on the left side of the page shows available satellites and identifies the GNSS constellation to which they belong. The color of the satellite symbol identifies its status:

- White = searching for satellite
- Green = satellite in use
- Orange = tracking satellite

GPS/GNSS settings

The settings for your display's GPS/GNSS receiver can be accessed by selecting on the from the homescreen.

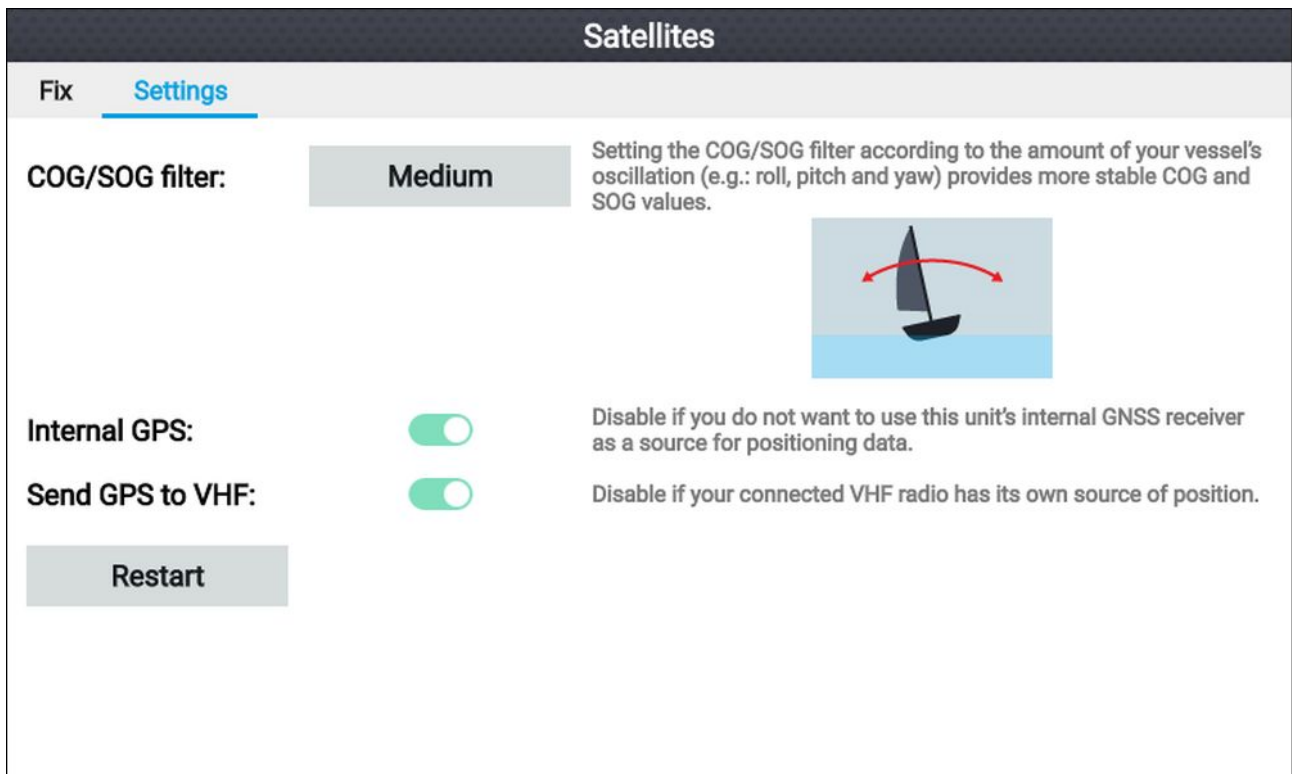

From the GPS/GNSS Settings tab you can:

- set the COG/SOG filter according to your vessel's oscillation, providing more stable COG and SOG readings
- enable and disable your display's GPS/GNSS receiver. Only disable if you do not want to use the Chart app for navigation.
- restart the display's GPS/GNSS receiver.

Source of position data

Your display's built-in GNSS (GPS) will provide position data to a VHF radio connected to the same NMEA 2000 / SeaTalkng[®] network.

5.5 Status area

The status area is located at the top right of the homescreen. This area displays the current time and identifies the status of the display's sonar ping. The status area pop-over menu provides access to the timer and time and date settings.

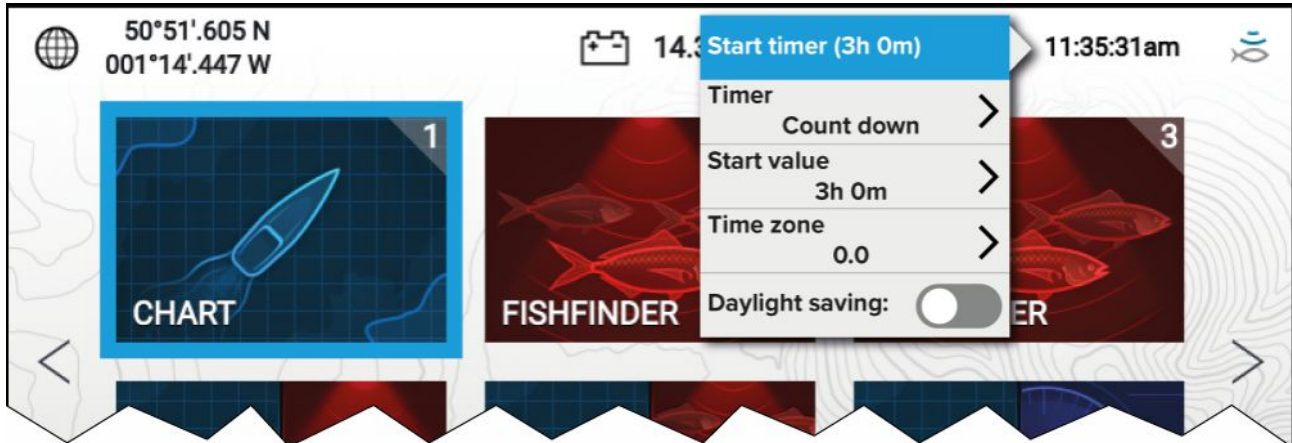

Status area icons

The icons displayed in the Status area signify the current status of certain connected devices.

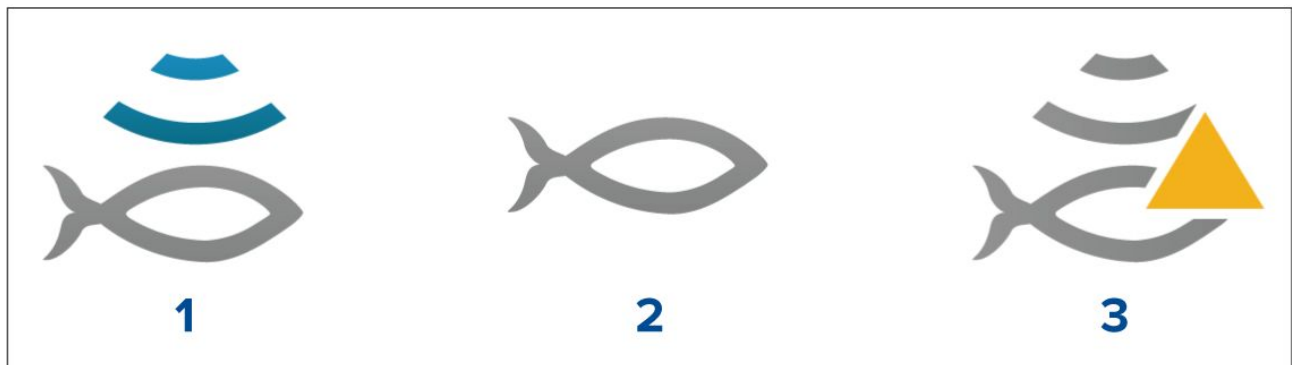

1. Sonar pinging.
2. Sonar ping disabled.
3. Sonar error.

5.6 Timer



A timer is provided in the homescreen status area. The timer can be used as a countdown timer or as a count-up (stopwatch).

Whilst the countdown or count-up timer is in use it is displayed in the status area, below the current time.

Using the count down timer

From the homescreen:

1. Select the status area, located in the top right corner of the homescreen.
2. The status area pop-over menu is displayed.
3. Ensure that **Count down** is selected in the **Timer** option.
4. Select **Start value** and adjust to the desired value.

The count down timer can be set to a maximum of 9 hours and 59 minutes.

5. Press the **Back** button to return to the pop-over menu.
6. Select **Start timer**.

The count down timer can be stopped or reset at anytime from the pop-over menu.

Using the count up timer

From the homescreen:

1. Select the status area, located in the top right corner of the homescreen.
2. The status area pop-over menu is displayed.
3. Ensure that **Count up** is selected in the **Timer** option.
4. Select **Start timer**.

The count up timer can count upwards to a maximum of 23 hours and 59 minutes.

The count up timer can be stopped or reset at anytime from the pop-over menu.

5.7 Alarms

Alarms are used to alert you to a hazard or situation requiring your attention. Alarms are triggered based on their specified thresholds.

The following alarms can be configured on your display:

- Shallow depth
- Waypoint arrival
- Low voltage
- Off track
- Anchor drift
- Water temperature
- Fish detection
- Engine alarms
- Satellite lost fix

Alarms are color coded to signify their severity:

Dangerous alarm example

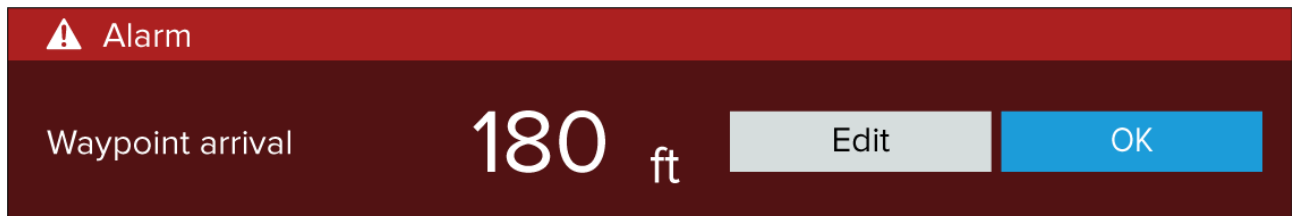

Red — is used to signify a dangerous alarm condition, immediate action is required due to a potential or immediate danger to life or vessel. Dangerous alarms are accompanied by an audible tone. The Dangerous alarm notification and audible tone will continue to be displayed until acknowledged or the conditions that triggered the alarm are no longer present.

Warning alarm example

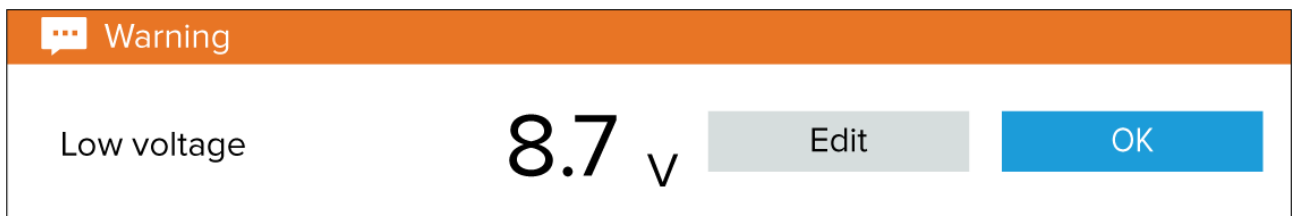

Orange — is used to signify a warning alarm condition. Warning alarms are used to signify that there has been a change in situation that you need to be aware of. Warnings alarms are accompanied by an audible tone. The warning alarm notification and audible tone will continue to be displayed until acknowledged or the conditions that triggered the alarm are no longer present.

Notification example



Blue — is used to signify information requiring user acknowledgement. Information notifications may self dismiss after 3 seconds, unless they require user interaction. Information notifications are not accompanied by an audible tone.

Acknowledging alarms

Follow the steps below to acknowledge an active alarm.

With an alarms notification displayed onscreen:

1. Select **OK**.

The notification is dismissed and the audible tone is stopped.

An acknowledged alarm remains active until the conditions that triggered the alarm are no longer present.

Note:

If an alarm notification includes an **Edit** button, selecting it will display the relevant setting in the Alarms menu so that, if required, you can change the alarm threshold.

5.8 Settings menu

The display's settings can be accessed by selecting the **Settings** icon on the Homescreen.

The following settings and details are available for your display.

Tab	Settings
Getting started	<ul style="list-style-type: none"> • Hardware and software information about your display. • Update display software. • Change the user interface language. • Enable/disable Retail/demo mode (Simulator mode). • Enable/disable Demo movie. • Choose a Demo type. • View the Terms of Use disclaimer.
Boat details	<ul style="list-style-type: none"> • Configure Minimum safe depth, height and width. • Configure engines. • Configure tanks. • Configure batteries.
Units	<ul style="list-style-type: none"> • Configure preferred units of measurement. • Configure date and time settings. • Configure Bearing mode. • Configure system datum. • Configure variation.
This display	<ul style="list-style-type: none"> • Switching between Light and Dark user interface color themes. • Calibrate an EV-1 heading sensor • Troubleshooting: Save or Erase error logs, Save system logs, view product information for diagnostics purposes. • Perform a Settings or Factory reset.
Alarms	<ul style="list-style-type: none"> • Configure alarm settings.
Import/export	<ul style="list-style-type: none"> • Import and export user data (Waypoints, Routes and Tracks) from MicroSD card. • Eject SD card.

Selecting display language

You can choose which language you want the display's user interface to use.

1. Select the **Language** button from the **Getting started** menu: **Homescreen > Settings > Getting started**.
2. Select your desired language.

User Interface languages

The following languages are available:

Arabic (ar-AE)	Bulgarian (bg-BG)	Chinese (Simplified) (zh-CN)	Chinese (Traditional) (zh-TW)
Croatian (hr-HR)	Czech (cs-CZ)	Danish (da-DK)	Dutch (nl-NL)
English (en-GB)	English (en-US)	Finnish (fi-FI)	French (fr-FR)
German (de-DE)	Greek (el-GR)	Hebrew (he-IL)	Hungarian (he-IL)
Icelandic (is-IS)	Indonesian (Bahasa) (id-ID)	Italian (it-IT)	Japanese (ja-JP)

Korean (ko-KR)	Latvian (lv-LV)	Lithuanian (lt-LT)	Malay (Bahasa) (ms-MY ZSM)
Norwegian (nb-NO)	Polish (pl-PL)	Portuguese (Brazilian) (pt-BR)	Russian (ru-RU)
Slovenian (sl-SI)	Spanish (es-ES)	Swedish (sv-SE)	Thai (th-TH)
Turkish (tr-TR)	Vietnamese (vi-VN)		

Boat details

To ensure correct operation and display of data you should set the Boat Details settings according to your requirements.

Boat details can be accessed from the **Settings** menu: **Homescreen > Settings > Boat Details**

Option	Description
Min safe height:	Enter your vessel's maximum unladen height from the waterline. To ensure adequate clearance, it is recommended that you add a safety margin to this figure to allow for variation caused by vessel movements.
Min safe width:	Enter your vessel's maximum width at its widest point. To ensure adequate clearance on both sides, it is recommended that you add a safety margin for port and starboard to this figure to allow for variation caused by vessel movements.
Min safe depth:	Enter your vessel's maximum depth when fully laden. This is the depth from the waterline to the lowest point on the vessel's keel. To ensure adequate clearance, it is recommended that you add a safety margin to this figure to allow for variation caused by vessel movements.
Num of engines:	You can configure your system to display data for up to 2 engines, when connected to a compatible engine management system.
Identify engines:	Once you have selected the number of engines, select Identify engines and follow the onscreen instructions to configure your engines. May require an extra hardware interface to enable engine data to be displayed.
Fuel tanks:	You can configure your system to display data for up to 2 fuel tanks.
Fresh water tanks:	You can configure your system to display data for up to 2 fresh water tanks.
Live well tanks:	You can configure your system to display data for up to 2 Live well tanks.
Gray water tanks:	You can configure your system to display data for a Gray water tank.
Black water tanks:	You can configure your system to display data for a Black water tank.
Num of Batteries:	You can configure your system to display data for up to 3 batteries.

Units of measure

You can select your preferred units for data readings from the **Units** menu: **Homescreen > Settings > Units**.

Default units of measure are determined by the selected user interface language.

Measurement	Units
Distance units:	<ul style="list-style-type: none"> • Nautical Miles • NM & m • Statute Miles • Kilometers
Speed units:	<ul style="list-style-type: none"> • Kts • MPH • KPH

Measurement	Units
Depth units:	<ul style="list-style-type: none"> • Meters • Feet • Fathoms
Temperature units:	<ul style="list-style-type: none"> • Celsius • Fahrenheit
Volume units:	<ul style="list-style-type: none"> • US Gallons • Imperial Gallons • Liters
Economy units:	<ul style="list-style-type: none"> • Distance per Volume • Volume per Distance • Liters per 100 km
Pressure units:	<ul style="list-style-type: none"> • Bar • PSI • Kilopascals
Date format:	<ul style="list-style-type: none"> • MM:DD:YYYY • DD:MM:YYYY • MM:DD:YY • DD:MM:YY
Time format:	<ul style="list-style-type: none"> • 12hr • 24hr
Time zone:	<ul style="list-style-type: none"> • UTC offsets

Chapter 6: Waypoints, Routes and Tracks

Chapter contents

- [6.1 Waypoints on page 56](#)
- [6.2 Routes on page 62](#)
- [6.3 Tracks on page 66](#)

6.1 Waypoints

Waypoints are used to mark specific locations or points of interest. Waypoints can be used in the Chart and Fishfinder apps. Your display can store up to 5,000 waypoints which can be sorted into up to 200 waypoint groups.

In the Chart app you can navigate to a waypoint by selecting **Goto** from the Waypoint context menu.

Waypoints can be imported and exported from the display refer to: [4.6 User data import and export](#)

Placing a waypoint (Quick method)

To place a waypoint at a specific location in the Chart or Fishfinder apps, follow the steps below.

1. Use the **Directional pad** to place the cursor over the desired location and press the **Waypoint** button.

The app will be in cursor mode and the waypoint saved notification is displayed.

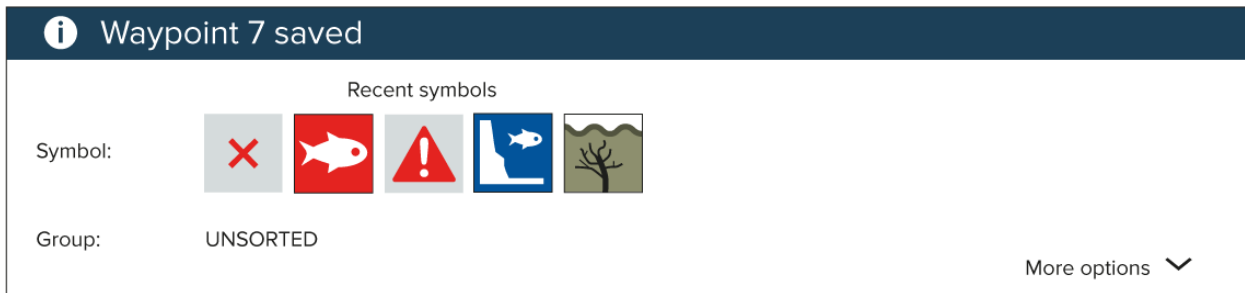

Note:

If there is no interaction with the notification within 5 seconds the notification will automatically close, saving the waypoint with the default values.

2. If required, select a recent waypoint symbol that you want to assign to the waypoint.
3. Press the **OK** button.

The waypoint will be saved with the chosen symbol, in the waypoint group shown against **Group:**

Placing a waypoint at your vessel's location

To place a waypoint at your vessel's locations follow the steps below.

Note:

For a waypoint to be placed at your vessel's location your display must have a GPS/GNSS position fix.

1. If, required press the **Back** button to enter Motion mode in the chart app, or Scrolling mode in the fishfinder app.
2. Press the **Waypoint** button.

The app will be in cursor mode and the waypoint saved notification is displayed.

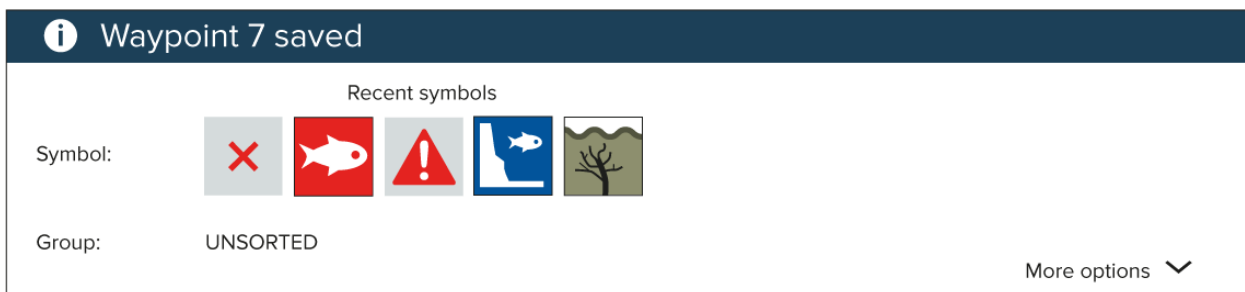

Note:

If there is no interaction with the notification within 5 seconds the notification will automatically close, saving the waypoint with the default values.

3. If required, select the a recent waypoint symbol that you want to assign to the waypoint.
4. Press the **OK** button.

The waypoint will be saved with the chosen symbol, in the waypoint group shown against **Group:**

Placing a waypoint (Detailed method)

You can place a waypoint at a specified location or at the vessel's location and modify the defaults settings (e.g.: waypoint name, symbol or group etc.) by following the steps below.

1. Use the **Directional pad** to place the cursor over the desired location and press the **Waypoint** button.

The app will be in cursor mode and the 'waypoint saved' notification is displayed.

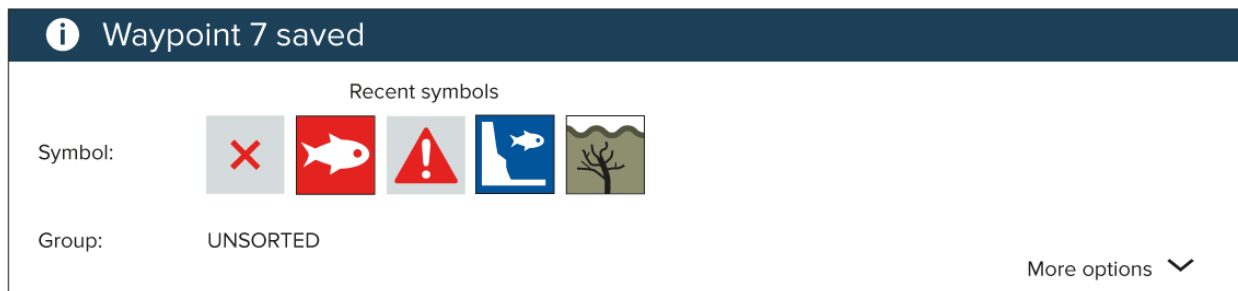

Note:

If there is no interaction with the notification within 5 seconds the notification will automatically close, saving the waypoint with the default values.

2. Press the **Down** button.

The 'new waypoint options' menu is displayed.

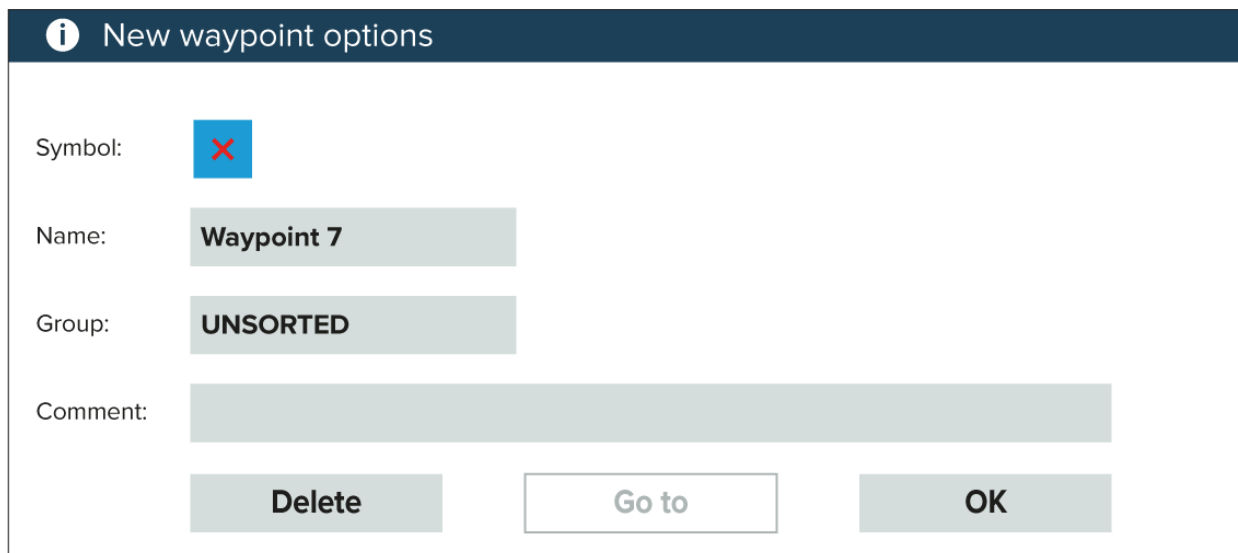

3. You can select the waypoint symbol to view a list of available symbols and then select the symbol you want to use.
4. You can select the **Name:** field to open the onscreen keyboard and customize the name of your waypoint.
5. You can select the **Group:** field to open the list of waypoint groups and either choose an existing or create a **New group**.
6. You can also add notes about the waypoint by selecting the **Comment:** field and using the onscreen keyboard.
7. When you have finished customizing the waypoint details, press the **OK** button to save the details, or.
8. You can select **Goto** to begin navigation to the new waypoint.

Note:

Selecting **Delete** will delete the waypoint.

Moving a waypoint

You can move an existing waypoint to a new location by following the steps below.

1. Select the waypoint that you want to move.
2. Select **more options** from the context menu.

3. Select **Move**.
4. Use the Directional pad to move the waypoint to the new location.
5. Press the **OK** button.

The waypoint has now been moved to its new location.

Note:

When moving a waypoint from a route that was generated using autorouting, the new position and route leg are not recalculated using the autorouting feature and the waypoint symbol will not change.

Waypoint management

Waypoints are sorted and displayed in waypoint groups menu.

Waypoint groups menu

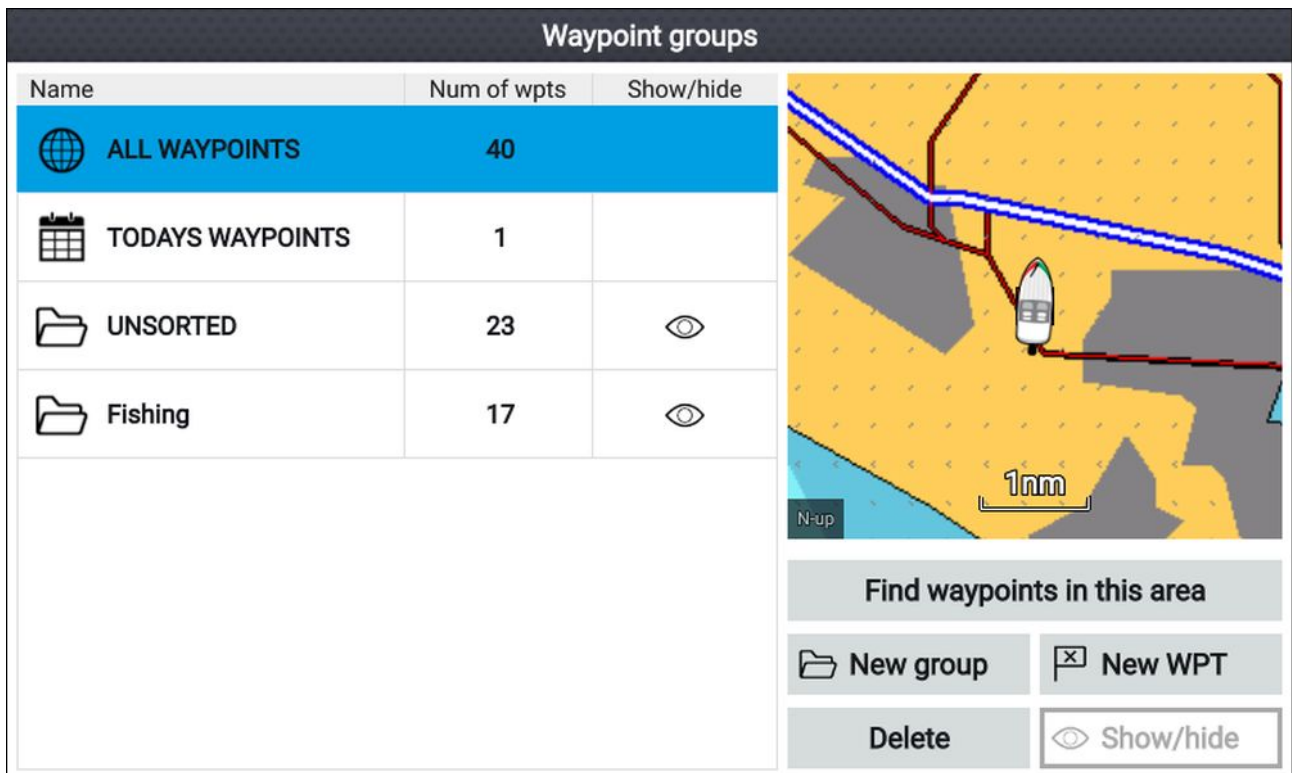

Waypoints can be viewed from the waypoint menu which can be accessed from the Homescreen (**Homescreen > Waypoints**) and from the Chart app (**Chart app > Menu > Waypoints**).

Waypoints will be saved to the same group as the last waypoint you created. All waypoints can also be viewed by selecting **ALL WAYPOINTS** and waypoints created the same day can be viewed by selecting **TODAYS WAYPOINTS**.

You can use the waypoint groups menu options to:

- Find nearby waypoints.
- Create a new waypoint group.

Note: Waypoint group names can be any combination of letters, numbers, symbols and special characters and can include up to 16 characters. Waypoint group names must be unique.

- Create a new waypoint.
- Delete a waypoint or waypoint group.

Waypoint groups

Fishing group

Name	Date created	
Fishing 		
Waypoint 34	01:44am 05/18/2017	
Waypoint 35	01:44am 05/18/2017	
Waypoint 36	01:44am 05/18/2017	
Waypoint 37	01:43am 05/18/2017	
Waypoint 38	01:43am 05/18/2017	
Waypoint 33	12:59am 05/18/2017	
Waypoint 39 ▼	12:59am	

ENTRADA 8,3 CHANNEL

1nm

Find waypoints in this area

Multi-edit
New waypoint

Selecting **ALL WAYPOINTS**, **TODAYS WAYPOINTS**, **UNSORTED** or a user created waypoint group will display a list of all the waypoints in that group / category.

With a list of waypoint displayed you can:

- Find waypoints located in the area covered by the LiveView pane.
- Edit multiple waypoints (i.e.: you can change the symbol used for multiple waypoints, move multiple waypoints to a different group or delete multiple waypoints).
- Create a new waypoint in the current waypoint group.
- View and customize waypoint details.

Waypoint details

Waypoint 40

Name:	Waypoint 40	<p style="font-size: x-small;">1nm</p>
Symbol:		
Group:	Fishing	
Position:	50°51'.615 N 001°14'.449 W	
Bearing:	000.0°T	
Water temp:	--	Depth: --
Time:	10:31:05am	Date: 01/31/2019
Comment:		

Delete
Go to

Selecting a waypoint from the list displays customizable details for that waypoint. The waypoint's location is also displayed in the LiveView pane on the right side of the screen

With the waypoint details displayed you can:

- Edit the waypoint's Name.

Note: Waypoint names can be any combination of letters, numbers, symbols and special characters and can include up to 16 characters. Waypoint names must be unique.

- Change the waypoint's symbol.
- Assign or change the waypoint group.
- Enter new position coordinates for the waypoint.
- Add or edit the waypoint comment.

Note: Waypoint comments can be any combination of letters, numbers, symbols and special characters and can include up to 32 characters.

- Delete the waypoint.
- Perform a Go to.
- View the waypoint in the chart app.

Creating a waypoint group

To create a new waypoint group follow the steps below.

From the homescreen:

1. Select **Waypoints**.
2. Select **New group**.
3. Enter a name for the group using the onscreen keyboard.
4. Select **Save**.

The new waypoint group will become the new default group for all new waypoints.

Deleting a waypoint group

To delete a waypoint group follow the steps below.

From the homescreen:

1. Select **Waypoints**.
2. Select **Delete**.
3. Select the Group that you want to delete.
4. Select **Delete selected**.
5. Select **Yes**.

The waypoint group and waypoints that are assigned to that group will be deleted.

Creating a waypoint based on coordinates

You can manually create a waypoint based on the coordinates of the location where you want the waypoint placed.

From the homescreen:

1. Select **Waypoints**.
2. Select **New WPT**.
3. Enter the relevant details in the available fields.
4. Choose a waypoint symbol.
5. Enter the position coordinates where you want the waypoint placed by selecting on the **Position:** field and using the onscreen keypad to enter the latitude and longitude for the location where you want the waypoint placed..

By default your vessel's coordinates will be displayed.

6. Select **Save** to return to the waypoint details.
7. Press the **Back** button to return to the Waypoint groups menu.

Finding nearby waypoints

You can find waypoints that are within the LiveView pane by following the steps below.

The waypoint find feature will find and create a list of all waypoints located within the area covered by the LiveView pane.

From the homescreen:

1. Select **Waypoints**.
2. To find waypoints that are located within the area covered by the LiveView pane, select **Find waypoints in this area**, otherwise
3. Highlight a waypoint in the waypoint list and select **Find waypoints in this area**.

A list of all the found waypoints will be shown in the waypoint list.

Panning the LiveView area

You can change the chart area displayed in the LiveView.

1. Open the **Waypoints** menu.

*The waypoints menu can be accessed from the Homescreen (**Homescreen > Waypoints**) and from the Chart app (**Chart app > Menu > Waypoints**).*

2. Press the **Right** button.
Find waypoints in this area will be highlighted.
3. Press the **Up** button.
Focus will move to the LiveView pane.
4. Press the **OK** button.
The LiveView pane will enter panning mode.
5. Use the **Directional pad** to pan the chart area to the desired location.
6. Press the **Back** button.
7. Select **Find waypoints in this area**.

Showing and hiding waypoint groups

When the waypoint menu is accessed from the chart app you can hide and show waypoints.

From the chart app:

1. Press the **Menu** button.
2. Select **Waypoints**.
3. Select **Show/hide**.
The list of waypoint groups is displayed, all waypoint groups are selected (ticked) by default.
4. Deselect any groups that you do not want to change.
You can also use the **Show all** and **Hide all** options if you want to show or hide all of your waypoints.
5. Press the **Back** button to return to the waypoints menu.

Note:

The **Show/hide** options is not available when accessing the waypoint menu form the homescreen.

6.2 Routes

Routes are used to plan your journey in advance. You can plan your journey directly on your display, or at home using software capable of exporting waypoints and routes in standard .gpx format.

Routes consist of a number of waypoints. Your display can store up to 50 routes, each route consisting of up to 250 waypoints. When creating routes the route capacity is subject to the display's 5,000 waypoint limit (e.g.: your display could store 20 routes each containing 250 waypoints).

To navigate a saved route, place the cursor over the route and press the **OK** button then select **Follow route** from the context menu.

Routes can be imported and exported from the display refer to: [4.6 User data import and export](#)

Creating a Route

Follow the steps below to build a new route

Routes can be created in the chart app.

Important:

Before following a route, you must ensure that each waypoint and leg of your route is safe for your vessel to navigate.

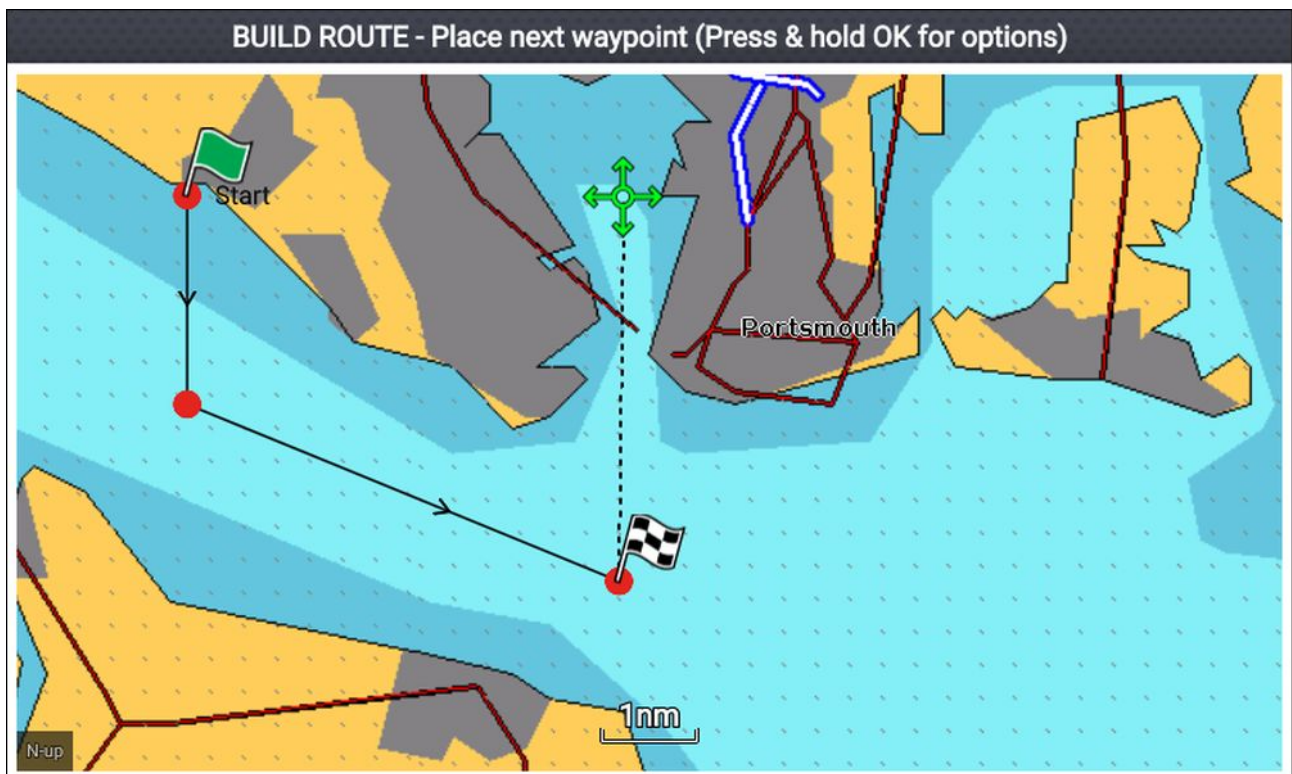

1. Select the location for the first waypoint.
2. Select **Build route** from the context menu.
3. Select the location for the second waypoint.
The 2 waypoints will be joined by a line, creating the first leg of your route.
4. Select the location for the subsequent waypoints, required to complete your route.
5. When your route is complete press and hold the **OK** button and then select **Finish build** from the context menu.
The finish route build notification is displayed.
6. From the notification you can either:
 - Select **Follow** to immediately start following the route, or
 - Select **Follow in reverse** to follow the route in reverse waypoint order, or
 - Select **Route plan** to view the route plan menu, or
 - Select **Exit** to return to the chart app.

Note:

You can press the **Back** button at anytime during route building to remove the last waypoint you placed.

Use Autorouting during route creation

Whilst building a route you can use Autorouting to automatically add a route leg to a route you have already started to create. The Autorouting features require compatible cartography.

1. Press and hold anywhere on screen and select either **Autoroute to wpt** or **Autoroute to here**.

*Selecting **Autoroute to wpt** will allow you to select a waypoint from your Waypoints list to include in your route, selecting **Autoroute to here** will create a route leg to the cursor's current position.*

Once an Autoroute leg has been added you can select **Finish route build** or add further manual or autoroute route legs.

Autorouting

Autorouting is available when using compatible cartography. Autorouting allows you to build a route automatically between a point on the chart and your vessel.



Selecting **Autoroute to here** from the chart context menu, or selecting **Autoroute to** from an existing waypoint's context menu will create a route automatically between your vessel and the chosen point.

The created route is generated by comparing data available on your cartography against the minimum safe distances specified in the **Boat details** menu: (**Homescreen > Settings > Boat details**).

Waypoints will not be placed in areas that conflict with your specified minimum safe distances. Caution symbols are used for waypoints that are near objects or restricted areas.

Never follow a route before checking each route leg is safe for your vessel.

Reviewing an automatically generated route

Before following any route you must ensure that it is safe to do so.

Upon Route completion:

1. Range in on each route leg and waypoint that make up the Route.
2. Check either side of the route leg and around the waypoint for any possible obstructions.

Obstructions can be charted objects or restricted areas. Routes generated automatically should use the caution waypoint symbol in areas where there are possible obstructions.

- Where obstructions exist move the necessary waypoints so that the waypoint and route leg is no longer obstructed.

Route management

Routes are managed using the routes and tracks menu.

The **Routes & Tracks** menu can be accessed from the Homescreen and from the Chart app: **Homescreen > Routes & Tracks**, or **Chart app > Menu > Routes & Tracks**.

When the routes and tracks menu is opened the routes menu is displayed by default.

Routes menu

The screenshot shows the 'Routes and Tracks' interface. On the left, there is a table with the following data:

Name	Length	Num of wpts	Show/hide
Route 1	10.35nm	5	
Route 2	2.53nm	2	

On the right, there is a map view showing a route (Route 1) plotted on a chart. The map includes labels for 'HILLHEAD', 'ROWNER', 'LEE PT', 'SEAST BRAMBLE', 'OSBORNE BAY', 'STOKES BAY', and 'THE 50'. A scale bar indicates 1nm. Below the map, there are three buttons: 'New route', 'Delete', and 'Show/hide'.







From the route menu you can **Delete** routes, create a **New route** using existing waypoints or **Show/hide** routes.

To view the route plan, select a route and choose **View route plan** from the pop-over menu.

Route plan

The route plan displays a list of all waypoints in the route and includes a LiveView pane showing the route's location.

Route plan: Route 1

Route	Brg	Dist	ETA
 Route 1 			
 Waypoint 57	044°T	3815nm	07:27am 07/26/2017
 Waypoint 58	180°T	2.18nm (3818nm)	08:24am 07/26/2017
 Waypoint 59	107°T	4.61nm (3822nm)	10:24am 07/26/2017
 Waypoint 60	007°T	2.39nm (3825nm)	11:27am 07/26/2017
 Waypoint 61	352°T	1.17nm (3826nm)	11:57am 07/26/2017



ETA based on current SOG: 2.3kts

Follow
Reverse

Add waypoint
Route options

Time: 12:00am 05/18/2017

From the route plan you can:

- navigate the route by selecting **Follow**
- change the route direction by selecting **Reverse**
- add an existing waypoint to the route by selecting **Add waypoint**
- change route options, such as route name, route color, route hide or delete the route by selecting the relevant option from the **Route options** pop-over menu.

Note: Route names can be any combination of letters, numbers, symbols and special characters and can include up to 16 characters. Route names must be unique.

By selecting a waypoint from the route plan you can use the pop-over menu to:

- change the position of the waypoint in the route by selecting **Move up** or **Move down**.
- remove the waypoint from the route by selecting **Remove from route**.
- delete the waypoint by selecting **Delete waypoint**.
- edit the waypoint details by selecting **Edit waypoint**.
- start to follow the route from the selected waypoints by selecting **Follow from here**.

6.3 Tracks

Tracks are used to record where you have been. Tracks are made up of track points that are created at regular time or distance intervals. You can store up to 15 tracks on your display, each track can contain up to 10,000 points.

Tracks can be converted into routes so that they can be followed.

Tracks can be imported and exported from the display refer to: [4.6 User data import and export](#)

Creating a track

You can record your vessel's voyage using Tracks. Once a Track is saved it can be converted to a route so that the same passage may be followed again at a later date.



With the chart app displayed:

1. If required, press the **Back** button to enter motion mode.
2. Press the **OK** button.
The boat details pop-over menu is displayed.
3. Select **Start track**.
Your vessel's voyage will now be recorded.
4. When your voyage is complete, select **Stop track** from the boat details pop-over menu.

You can also start a new track recording at anytime from the Routes & Tracks menu: accessible from the homescreen: **Homescreen > Route & Tracks** and from the chart app menu: **Menu > Routes & Tracks**.

Converting a track to a route

From the **Routes & Tracks** menu, accessible from the homescreen **Homescreen > Routes & Tracks** and the chart app: **Menu > Routes & Tracks**.

1. Select the **Tracks** tab..
2. Select the track that you want to convert.
3. Select **Create route from track** from the pop-over menu.
4. Select **OK** to return to the tracks menu, or.
5. Select **Edit** to view the route plan.

Track management

Tracks are managed using the tracks menu.

The **Routes & Tracks** menu can be accessed from the Homescreen and from the Chart app: **Homescreen > Routes & Tracks**, or **Chart app > Menu > Routes & Tracks** .

When the routes and tracks menu is opened the routes menu is displayed by default. Select the **Tracks** tab to display the tracks menu.

Track menu

Name	Points	Length	Show/hide
Track 1	67	0.53nm	
Track 8	10000	32.03nm	
Track 9	10000	7880nm	

Map controls:

- Start track
- Color mode: Change each day
- Record by: Time
- Interval: 2 secs
- Delete
- Show/hide

From the tracks menu you can:

- Start or Stop tracks recording.
- Change track recording settings.
- Delete tracks.
- Show or hide tracks.

By selecting a track from the list you can use the pop-over menu to:

- edit the track name.

Note: Track names can be any combination of letters, numbers, symbols and special characters and can include up to 16 characters. Track names must be unique.

- change the line color the track uses.
- Convert the track into a route.
- Delete the track.

Track settings

The following track settings are available which change the way tracks are recorded.

Menu item and description	Options	
<p>Color mode: Track line color can be set to a specific color, or you be changed automatically every day or after every track.</p>	<ul style="list-style-type: none"> • Red • Yellow • Green • Blue • Purple • Orange • Black • Change each day (default) • Change each track 	
<p>Record by: You can change the way that the track points, which make up the track are dropped In Auto the track interval is set automatically to minimize the track points used whilst maintaining the actual path taken</p>	<ul style="list-style-type: none"> • Auto • Time (default) • Distance 	
<p>Interval: You can change the interval at which track points are dropped.</p>	<p>Time intervals:</p> <ul style="list-style-type: none"> • 2 secs (default) • 5 secs • 10 secs • 30 secs • 1 min • 3 mins • 5 mins • 10 mins • 30 mins 	<p>Distance intervals</p> <ul style="list-style-type: none"> • 120 ft (default) • 300 ft • 600 ft • 0.20 nm • 0.50 nm • 1.00 nm

Chapter 7: Chart app

Chapter contents

- 7.1 Chart app overview on page 70
- 7.2 Navigation on page 79
- 7.3 Find nearest on page 82
- 7.4 RealBathy™ on page 84
- 7.5 Chart settings menu on page 86
- 7.6 SonarChart™ Live on page 90

7.1 Chart app overview

The chart app displays a representation of your vessel in relation to land masses and other charted objects, which enables you to plan and navigate to your desired destination. The chart app requires a GNSS (GPS) position fix in order to display your vessel at the correct location on a world map.

For each instance of the chart app you can select which electronic cartography you want to use. The selection will persist over a power cycle.

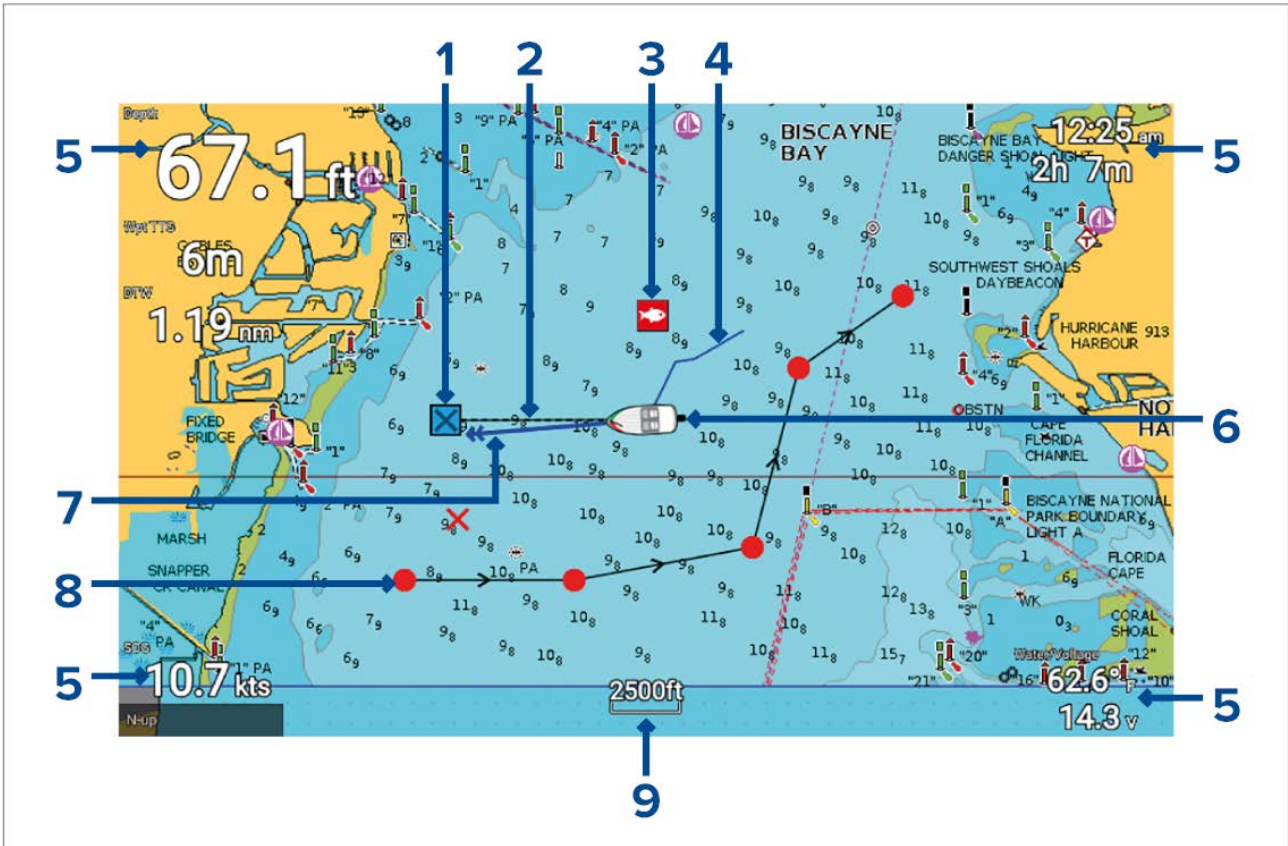

1	Destination waypoint During a go to, this is the current destination waypoint.
2	Destination line During a go to, a dashed line connects your vessel to the destination point.
3	Waypoint Use waypoints to mark specific locations or points of interest.
4	Track You can record the passage your vessel takes using Tracks.
5	Databoxes Databoxes display key information that is available on your system. You can configure which data is shown in each databox or the databoxes can be hidden.
6	Vessel icon This icon represents your vessel, only displayed when a GNSS (GPS) position fix is available. The icon is replaced with a Black dot if no heading or COG data is available).
7	COG line If Course Over Ground (COG) data is available, you can display a COG vector for your vessel.
8	Route You can plan your route in advance by creating a Route using waypoints to mark each route leg.
9	Chart range Identifies the scale for the displayed chart range.

Chart app controls

The chart app has 2 control modes, motion mode and cursor mode. The behavior of some controls are dependent upon control mode.

Motion mode

Motion mode is the default mode when the chart app is opened. In motion mode the vessel icon remains centered onscreen and the chart area automatically pans as progress is made.

Controls behavior:

- Pressing the **OK** button opens the vessel context menu.
- Pressing any button on the **Directional pad** will switch to Cursor mode.
- Pressing the **Waypoint** button will place a waypoint at your vessel's current location.
- Pressing the **Plus** or **Minus** buttons will range in and range out respectively, centered around your vessel .

Cursor mode

In cursor mode the chart area remains static and the vessel icon moves in the direction of travel.

Controls behavior:

- Pressing the **OK** button opens the context menu for the area or charted object directly under the cursor's position.
- Pressing any button on the **Directional pad** moves the cursor in the respective direction, when the cursor reaches the edge of the app window the chart area will pan in that direction.
- Pressing the **Waypoint** button will place a waypoint at the cursor's location.
- Pressing the **Plus** or **Minus** buttons will range in and range out respectively, centered around the cursor position.
- Pressing the **Back** button will re-center the vessel icon and switch back to Motion mode.

Chart ranging and panning

You can change the range (zoom level) in the chart app using the **Plus** and **Minus** buttons.

You can pan the chart area using the **Directional pad**.

Chart app context menu

Context menus provide context sensitive information and menu options.

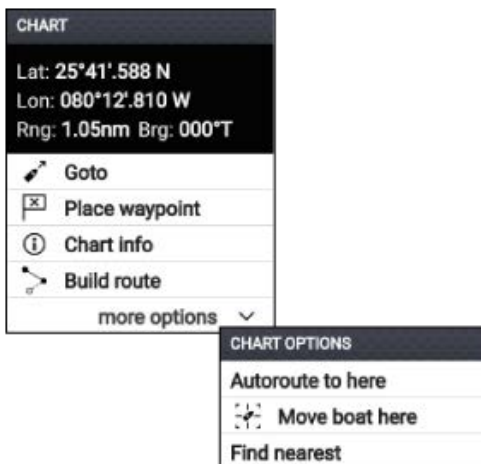

- The Chart app context menu is accessed by selecting a location or a cartographic object in the chart app.
- The context menu provides Latitude, longitude, range and bearing details for the selected location or object.
- The context menu provides quick access to relevant menu options.
- Select **more options** to display further options.

Note:

The **Move boat here** option is only available in Demo/simulator mode.

The following options are available from the chart context menu:

- Goto
- Place waypoint
- Chart info
- Build route
- Autoroute to here
- Move boat here
- Find nearest

Selecting a chart card

You can use LightHouse™ charts and compatible Navionics and C-MAP electronic charts. The electronic chart cards must be inserted into your display's MicroSD card reader.

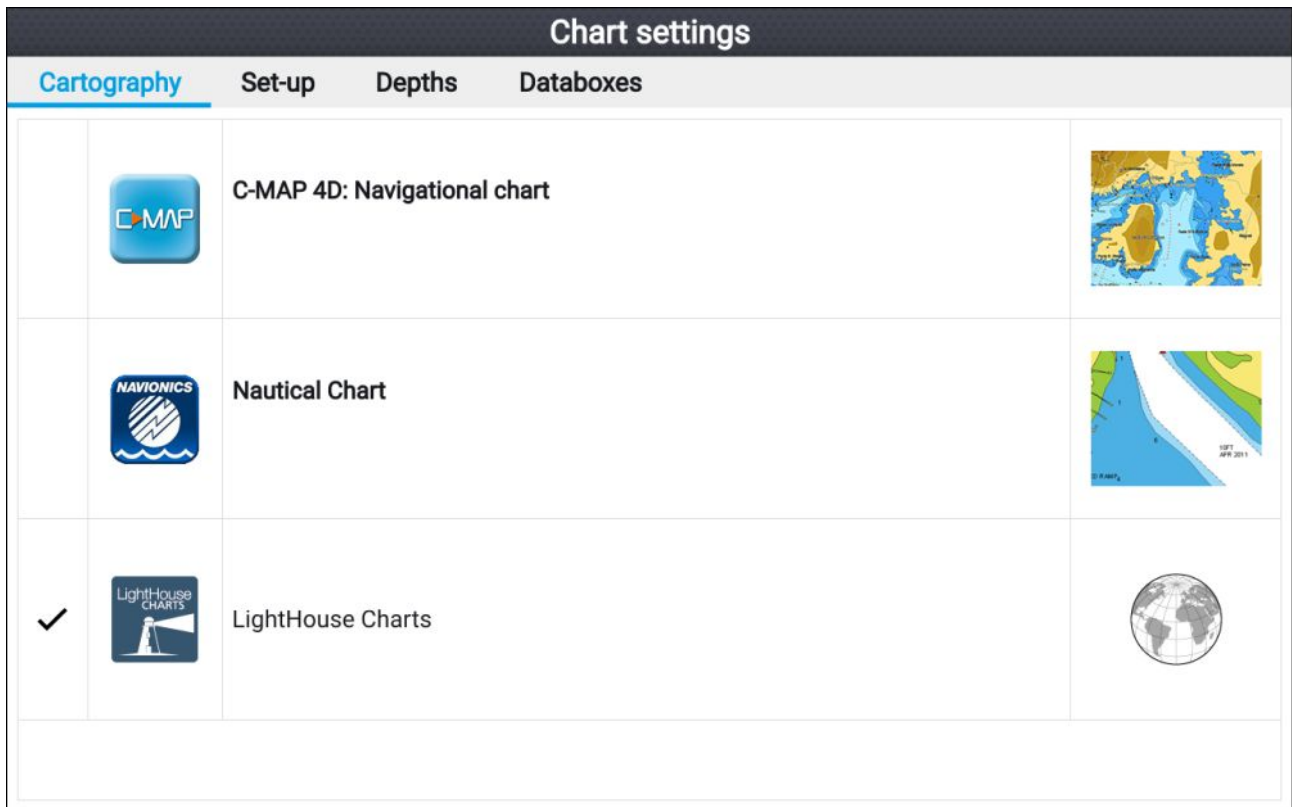

From the chart app:

1. Press the **Menu** button.
2. Select the **Settings** icon.

*Pressing the Directional pad's **Up** button once the menu opens will move to the bottom of the menu and highlight the settings icon.*

3. Select the cartography that you want to use from the Cartography tab.

The menu will close and the chart app will display your chosen cartography.

Chart modes

The chart app provides preset modes that can be used to quickly set up the chart app for your intended use.

To change chart mode select the required mode from the app menu.



SIMPLE

Simple mode suppresses chart detail to provide a clearer, simpler view for general orientation. In simple mode only navigation-related menu options are available. Changes made to settings are not saved in simple mode.



DETAILED

Detailed mode is the default mode. Full chart details and menu options are available. Changes made to settings are saved.



FISHING

Fishing mode optimizes the chart app for fishing. If supported by your cartography, fishing mode also displays more detailed contour lines. Full menu options are available. Changes made to settings are saved.



RUNNING

Running mode optimizes the chart app for fast running. In running mode, chart detail is suppressed and full vessel offset is applied providing a clearer view ahead, ideal for faster running conditions. Full menu options are available. The Chart app can be configured to enter running mode automatically when vessel speed exceeds 10 knots. Changes made to settings are saved.

View and motion

Controls are available which determine how the chart is displayed in relation to your vessel icon.

Chart motion

Chart motion controls how the chart and boat are drawn in relation to each other.

The following options are available:

- **Relative motion** — In relative motion the vessel icon remains fixed onscreen and the chart area moves relative to your position. In this mode you can adjust the fixed position of the vessel icon using the **Boat position** setting..
- **True motion** — In true motion the chart is fixed and your vessel icon moves around the chart. As the vessel icon reaches the edge of the screen, the chart is redrawn to reveal the area in front of your vessel.
- **Auto range** — In auto range the largest possible scale is maintained that will display both your vessel and the destination / target waypoint simultaneously.

Chart orientation

The orientation of the chart affects the alignment of the chart relative to either your vessel heading, your course or North.

The following options are available:

- **North-up** — In north-up the top of the screen always points towards north. As your vessel's heading changes, the vessel icon rotates accordingly.
- **Head-up** — In head-up the top of the screen always points towards your vessel's current heading, and as your heading changes the chart rotates accordingly.
- **Course-up** — In course-up the top of the screen always points towards your destination, and as your destination changes the chart rotates accordingly.

Boat position

The boat position determines the position of the vessel icon onscreen. Your boat position can only be changed when the **Chart motion** setting is set to **Relative motion**. You can change the position of the vessel icon to provide a greater distance in front of your vessel.

The following options are available:

- **Center** — Center is the default boat position and places the vessel icon in the center of the screen.
- **Partial offset** — Partial offset positions the vessel icon half way between the center and the bottom of the screen.
- **Full offset** — Full offset positions the vessel icon toward the bottom of the screen providing the greatest view ahead.

Vessel details

The Vessel details pop-over provides access to vessel-related settings.

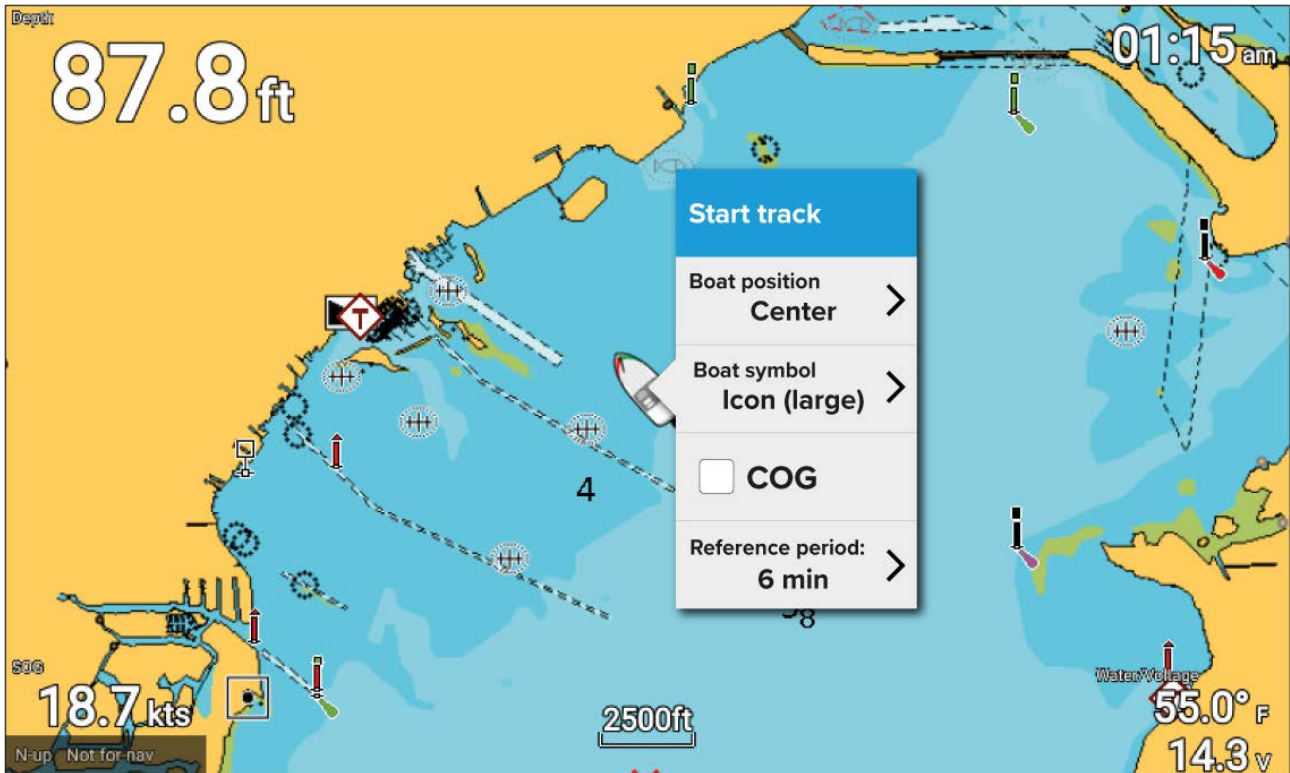

From the Vessel details pop-over you can:

- start/stop a track.
- offset the position of the boat symbol.
- change the symbol used to represent your vessel.
- show / hide COG vector.
- set the length of reference period for the COG line.

Viewing object information

Charted objects that are available with your cartography can be selected, and object information viewed.



When you select an object, the cursor will change to the Object cursor.

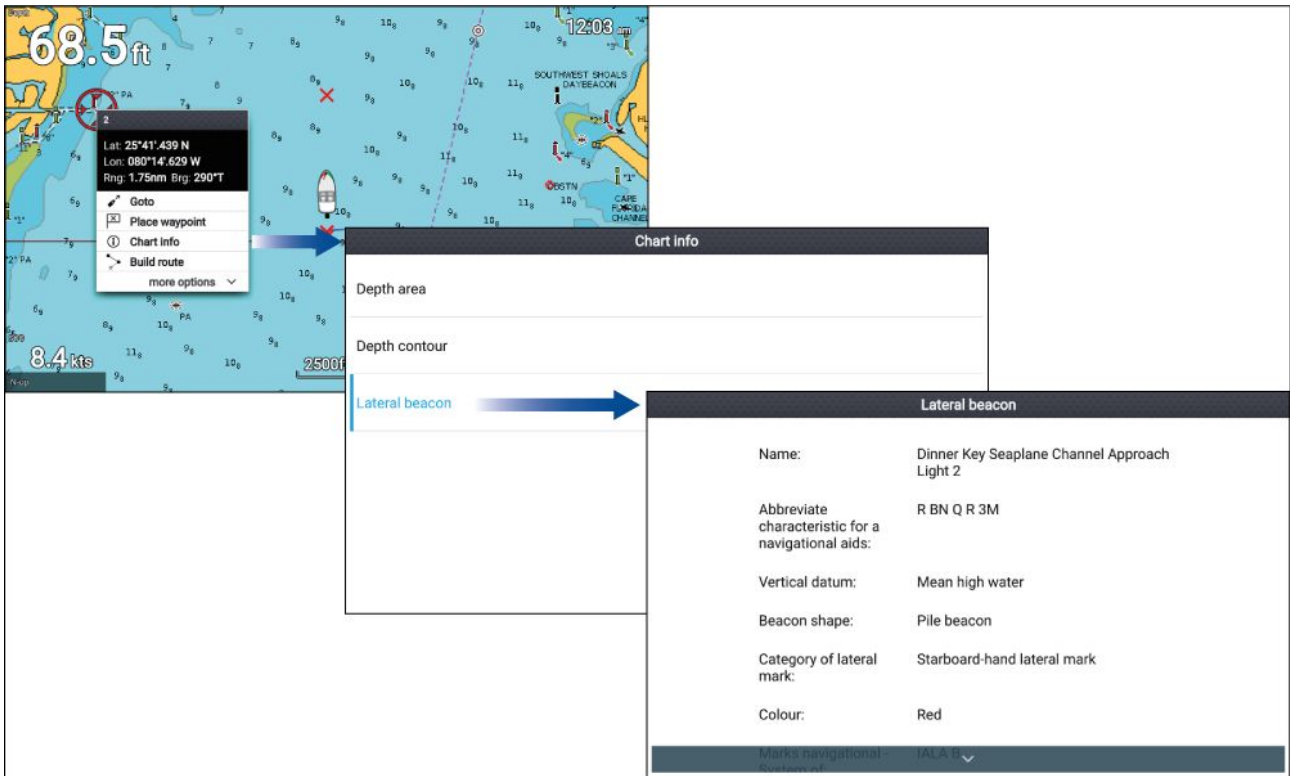

1. Press the **OK** button to display the object context menu.
2. Select **Chart info**.
A list of nearby objects is displayed.
3. Select an item from the list to display detailed related information.

Tide station information

Depending on your cartography, Tide station information may be available.

Tide station symbol



The location of Tide stations is marked on the chart using a diamond-shaped symbol with a 'T' in the middle.

- The symbol is colored Red when using Navionics cartography.
- The symbol is colored Black when using C-Map cartography.

Dynamic tide graphic

Using Navionics cartography, when the Tides is enabled (**Menu > Settings > Set-up > Tides**) the tide symbol is replaced with a dynamic tide height graphic:

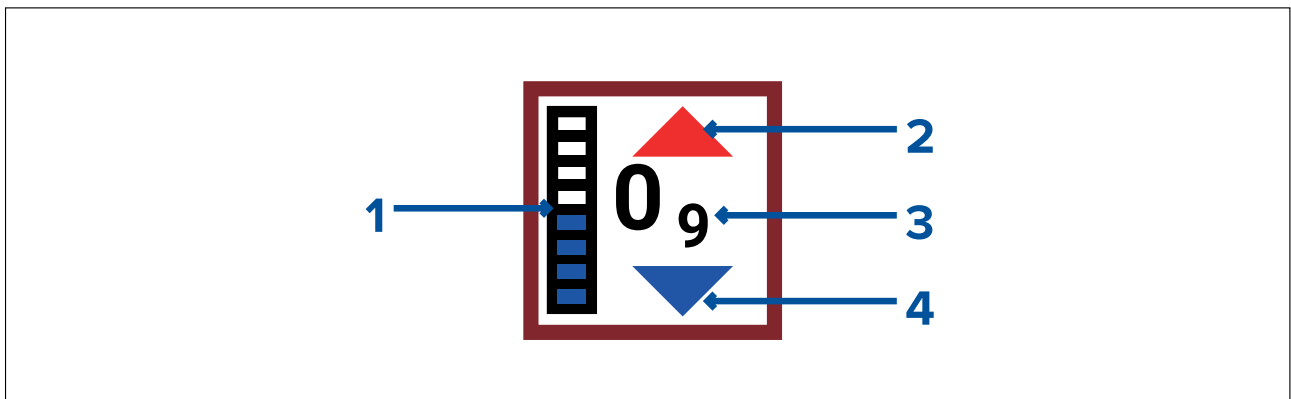

1. Tide bar — The tide bar plots the current tide height against the maximum predicted tide height for that day.
2. Red arrow indicates tide height is increasing.

- Tide height — Tide height is displayed in user-selected depth units, with decimals displayed in subscript. Decimals are not shown for values of 10 or greater.
- Blue arrow indicates tide height is decreasing.

Tide graph

Tide graphs are available with compatible cartography by selecting **more options** and then **Tide station** from the tide station's context menu.

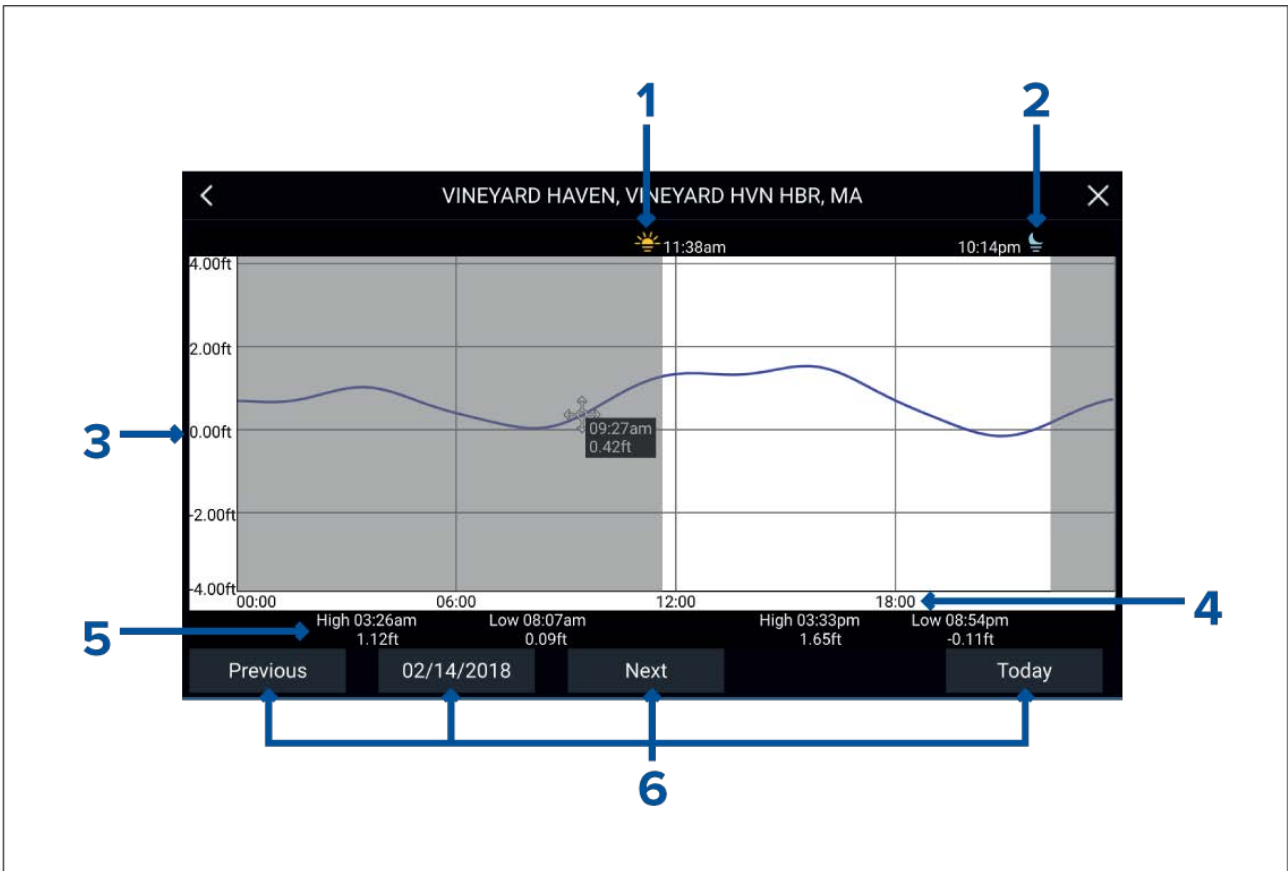

- Sunrise** — Indicates time of sunrise.
- Sunset** — Indicates time of sunset.
- Height** — Provides tide height in selected units.
- Time** — Indicates time of day.
- Low / High tide** — Indicates the time of low and high tides.
- Time and date options** — Use the buttons to view previous, next or today's tide predictions, or enter a date by selecting the date field.

Current station information

Depending on your cartography, Current station information may be available.

Current station symbol



Current station locations are marked on the chart using a diamond-shaped symbol with a 'C' in the middle.

- The symbol is colored Blue when using applicable Navionics cartography.
- The symbol is colored Black when using applicable C-Map cartography.

Dynamic current graphic

Using Navionics cartography, when the Tides option is enabled (**Menu > Settings > Set-up > Tides**), the tide symbol is replaced with a dynamic current graphic:



The dynamic current graphic is an arrow pointing in the direction of current flow. Arrow length indicates the speed of the current; the longer the arrow, the faster the speed.

The arrow's border indicates current status:

- Red = increasing current speed.
- Blue = decreasing current speed.

Current speed is shown inside the arrow. Current speed is displayed in user-selected speed units, with decimals displayed in subscript. Decimals are not shown for values of 10 or greater.

If tidal conditions are "slack", the word "SLACK" appears in a box with a Blue border.

When using C-Map cartography, arrows are used to indicate the direction of current flow. The size and color of the arrow indicates the strength of the current:

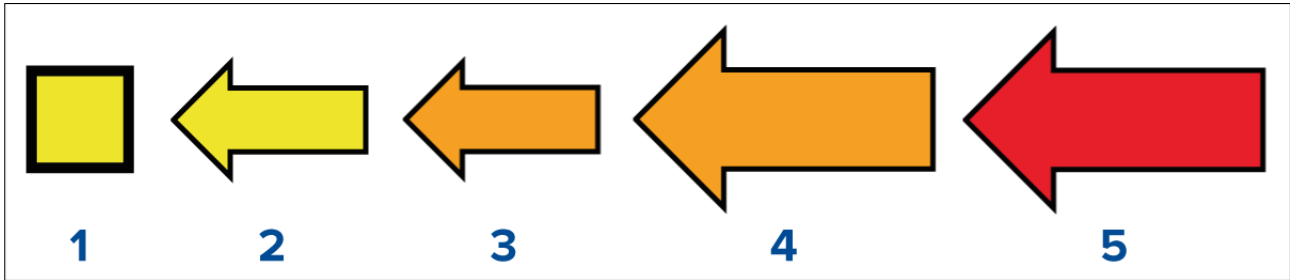

	Color	Speed
1	Yellow	0 to 0.1 Knots
2	Yellow	0.2 to 1.0 Knots
3	Orange	1.1 to 2.0 Knots
4	Orange	2.1 to 3.0 Knots
5	Red	>3.0 Knots

Current graph

Current graphs are available by selecting **more options** and then **Current station** from the current station's context menu.

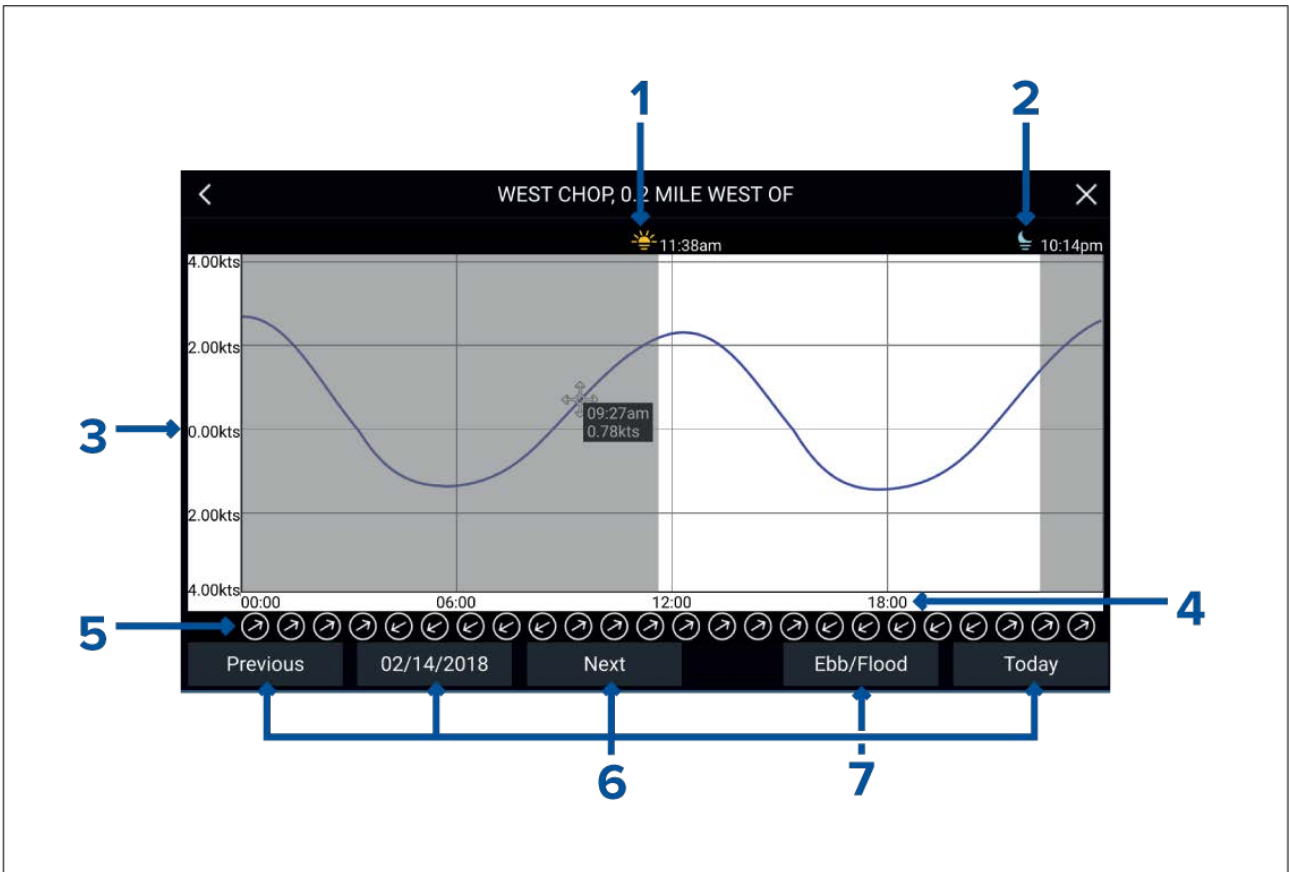

1. **Sunrise** — Indicates time of sunrise.
2. **Sunset** — Indicates time of sunset.
3. **Speed** — Provides current speed in selected units.
4. **Time** — Indicates time of day.
5. **Direction** — Indicates the direction of the current (relative to North).
6. **Time and date options** — Use the buttons to view previous, next or today's tide predictions, or enter a date by selecting the date field.
7. **Ebb / Flood** — Displays a list showing ebb, slack and flood tides.

7.2 Navigation

Navigating to a waypoint or point of interest

You can perform a “Goto” to a Waypoint or to a specific location.

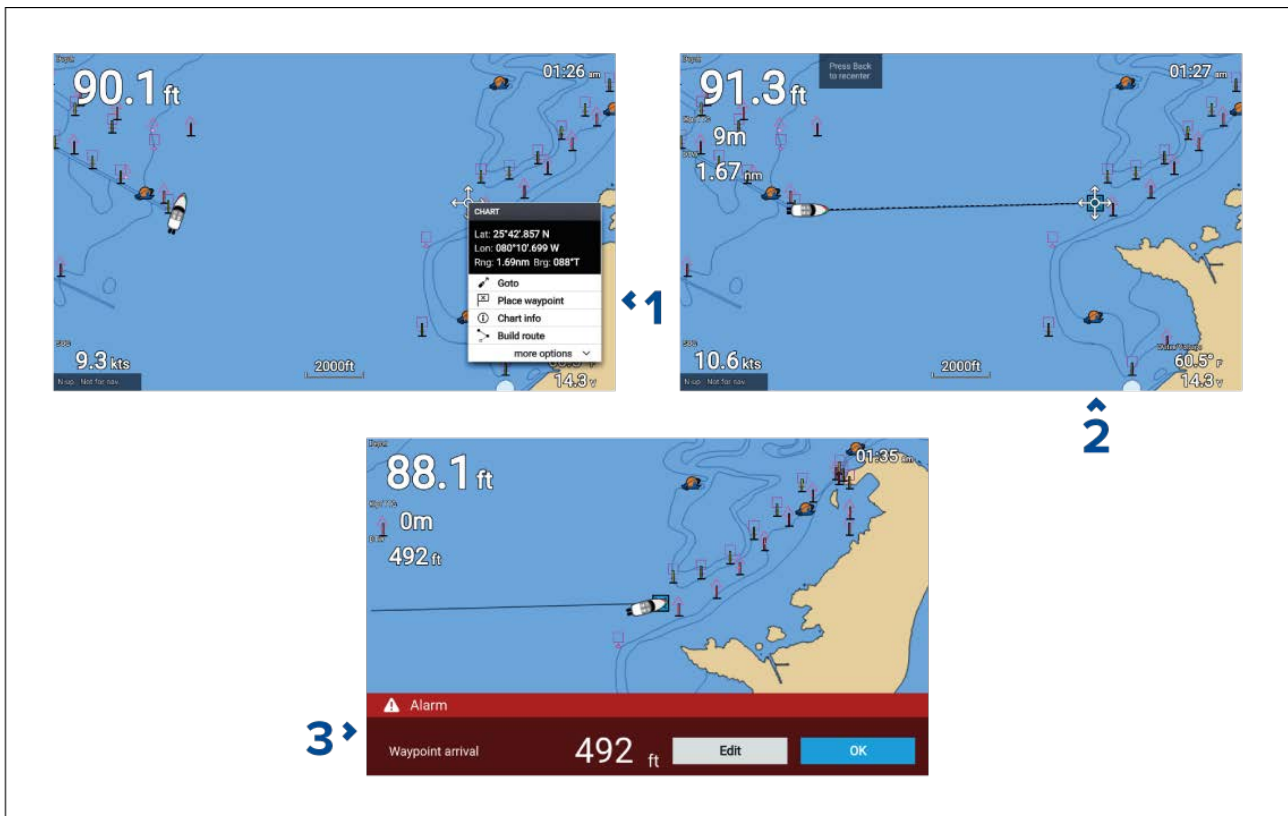

1. Select the waypoint or point of interest and select **Goto** from the context menu.

*You can stop the **Goto** at any time by selecting **Stop** from the context menu, or by selecting another **Goto**.*

The chart app will begin active navigation.

2. Navigate your vessel to the destination point, using the chart app as a guide.
3. Select **OK** to accept the waypoint arrival alarm, which is triggered when you reach a specified distance from the waypoint.

You can also perform a Goto from the **Go** menu: **Menu > Go** .

Adjusting the waypoint arrival alarm

The waypoint arrival alarm is enabled by default. The waypoint arrival alarm creates a virtual circle, of the specified radius, around the destination point. When your vessel reaches the virtual circle the alarm is triggered.

From the homescreen:

1. Select **Settings**.
2. Select the **Alarms** tab.
3. Select the **Arrival radius:** setting field.
4. Adjust the distance to the desired value.
5. Press the **Back** button to return to the alarms menu.

Note:

The waypoint arrival alarm can be disabled or enabled using the **Waypoint arrival:** toggle switch.

Restarting cross track error (XTE)

A cross track error (XTE) occurs when your actual route diverges from your original planned route. Restarting XTE plots a new course directly from your current position to your destination, rather than continuing to follow the original planned route.

1. Select **Restart XTE** from the **Navigation** menu: **Menu > Navigation > Restart XTE**.

Following a Route

Follow the steps below to navigate a saved route.

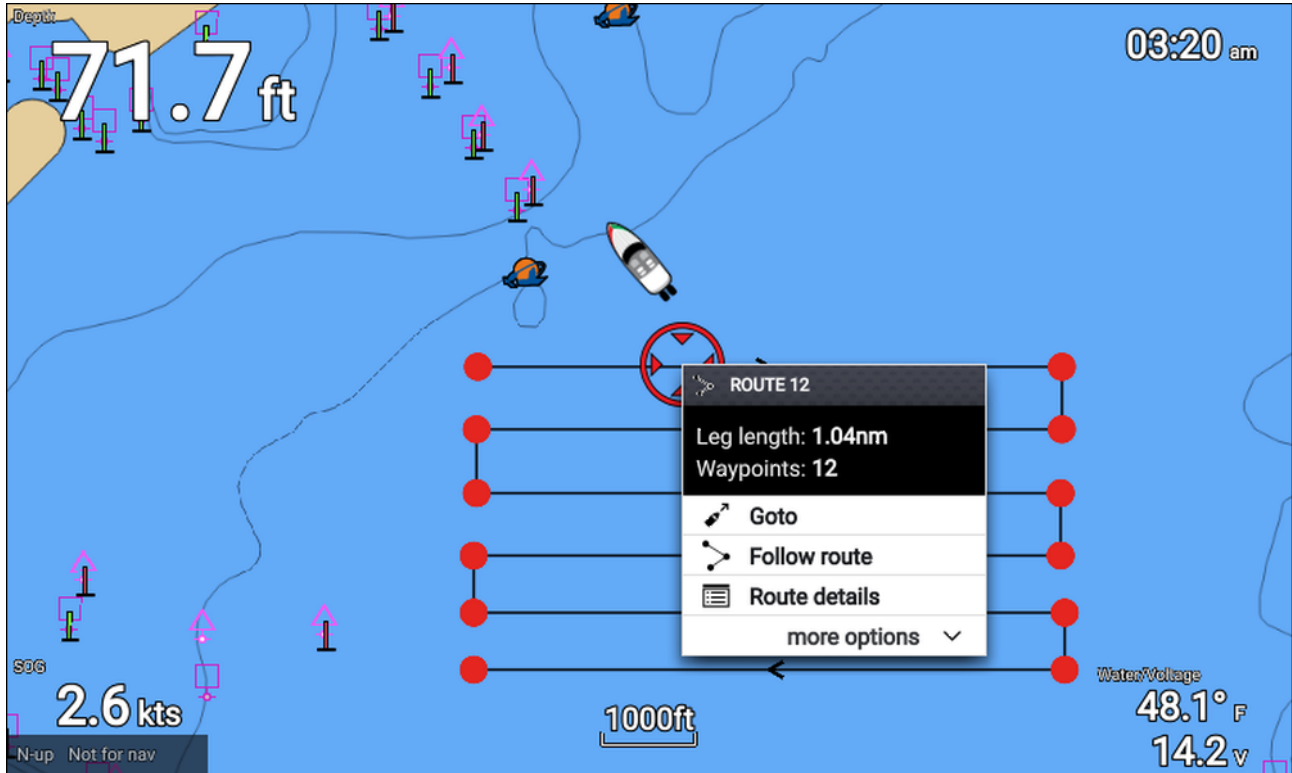

From the chart app, with the route displayed onscreen:

1. Select a route leg.
The route context menu is displayed.
2. Select **Follow route** to follow the route from start to finish.

Alternatively you can select Follow route from the route pop-over menu, accessed from the Routes menu. **Menu > Routes & Tracks > Routes > <Route name> > Follow**.

For more information on routes and route management refer to: [6.2 Routes](#)

Following a route from a specified waypoint

You can start following a route from any waypoint in that route.

From the chart app, with the route displayed onscreen:

1. Select the waypoint that you want to start following your route from.
The route context menu is displayed.
2. Select **more options**
3. Select **Follow from here**.

Creating a track

You can record your vessel's voyage using Tracks. Once a Track is saved it can be converted to a route so that the same passage may be followed again at a later date.



With the chart app displayed:

1. If required, press the **Back** button to enter motion mode.
2. Press the **OK** button.
The boat details pop-over menu is displayed.
3. Select **Start track**.
Your vessel's voyage will now be recorded.
4. When your voyage is complete, select **Stop track** from the boat details pop-over menu.

You can also start a new track recording at anytime from the Routes & Tracks menu: accessible from the homescreen: **Homescreen > Route & Tracks** and from the chart app menu: **Menu > Routes & Tracks**.

7.3 Find nearest

The Find nearest feature allows you to select a location and search for nearby objects or points of interest.

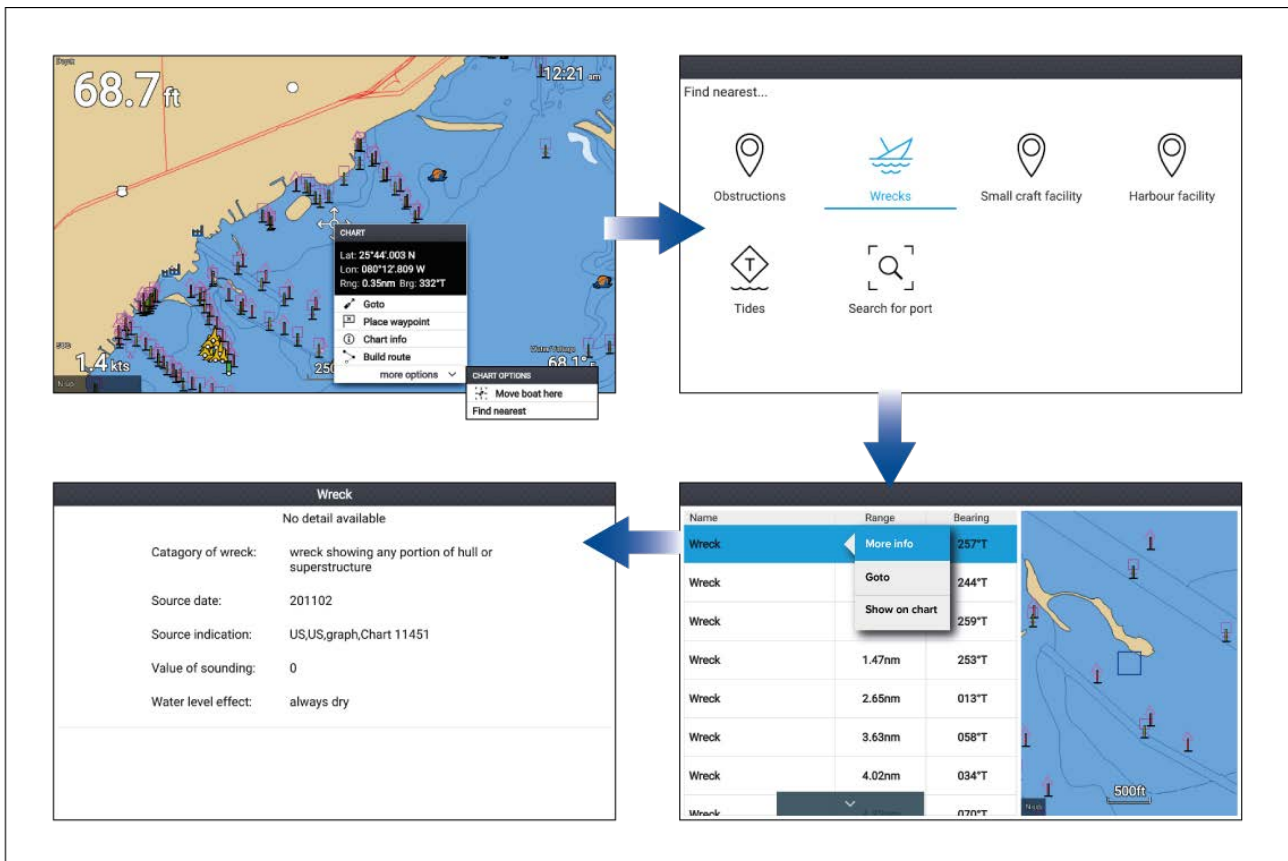

The objects available depend on the cartography you are using:

Object	Cartography
Obstructions	<ul style="list-style-type: none"> • LightHouse™ charts • Navionics® • C-MAP®
Wrecks	<ul style="list-style-type: none"> • LightHouse™ charts • Navionics® • C-MAP®
Small Craft Facility	<ul style="list-style-type: none"> • LightHouse™ charts
Harbor Facility	<ul style="list-style-type: none"> • LightHouse™ charts
Tide Station	<ul style="list-style-type: none"> • LightHouse™ charts • Navionics® • C-MAP®
Current Station	<ul style="list-style-type: none"> • LightHouse™ charts • Navionics® • C-MAP®
Port (Search by name)	<ul style="list-style-type: none"> • LightHouse™ charts • Navionics® • C-MAP®
Marinas	<ul style="list-style-type: none"> • Navionics® • C-MAP®

Object	Cartography
Lakes	<ul style="list-style-type: none"> • Navionics® • C-MAP®
Businesses	<ul style="list-style-type: none"> • Navionics®
Point of Interest	<ul style="list-style-type: none"> • C-MAP®
Outdoor Recreational Areas (ORA)	<ul style="list-style-type: none"> • C-MAP®
ORA Services	<ul style="list-style-type: none"> • C-MAP®
Port Services	<ul style="list-style-type: none"> • Navionics® • C-MAP®

Search using find nearest

To search for nearby objects, follow the steps below.

Note:

The list is sorted by an object's proximity to the selected location. However, the Range and Bearing displayed is relative to your vessel's position.

1. Select a location near where you want to search.
The chart context menu is displayed.
2. Select **more options**.
3. Select **Find nearest**.
4. Select the required object type.
5. If required, select a sub-category or when searching for a port, use the onscreen keyboard to enter a port name and select **Search**.
6. A list of nearby objects is displayed.
7. Select an object from the list.
The Pop-over menu is displayed and the **LiveView** on the right of the screen will highlight and zoom to the selected object.
8. From the Pop-over menu you can:
 - i. View more information about the object by selecting **More info**.
 - ii. Navigate to the selected object by selecting **Goto**.
 - iii. Display the selected object in the chart app by selecting **Show on chart**.

7.4 RealBathy™

You can create precise personal bathymetric charts in real time using Raymarine's RealBathy™ feature.

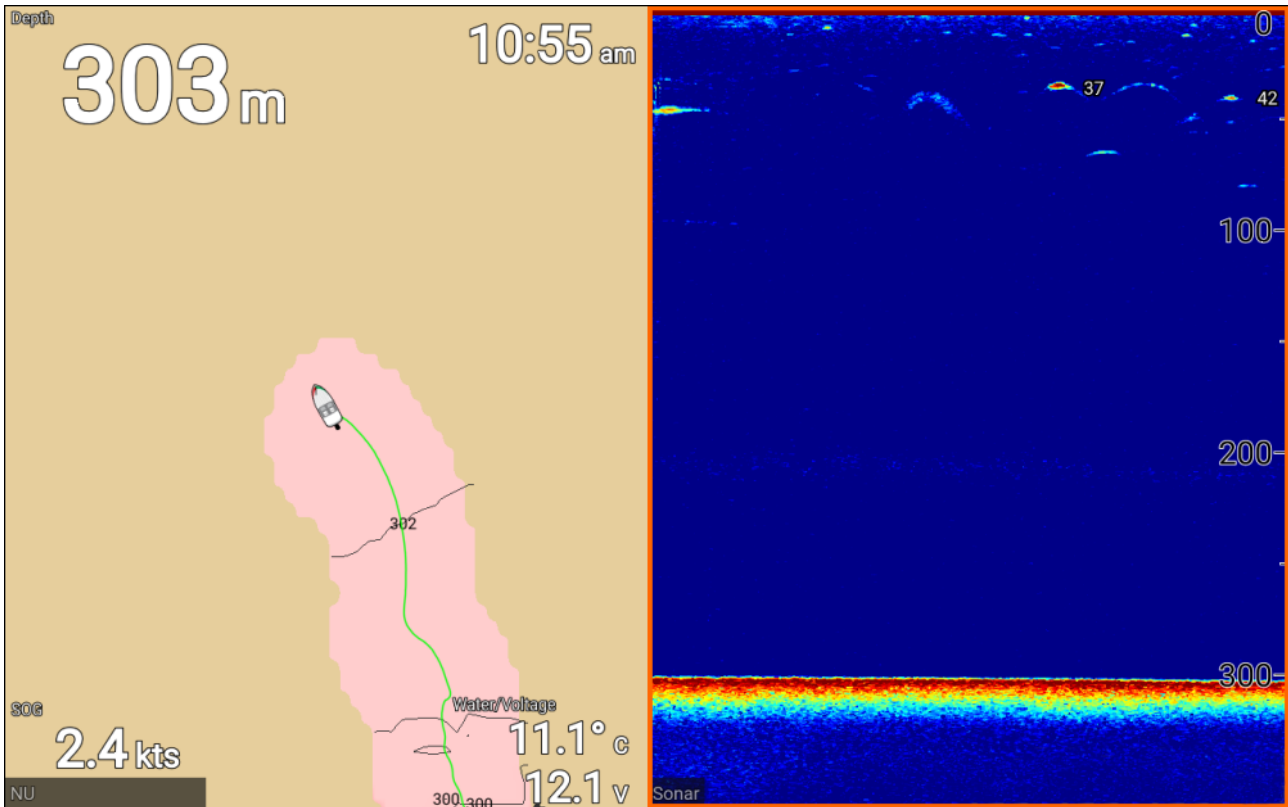

Note:

RealBathy™ requires compatible LightHouse™ NC2 charts and a MicroSD card with sufficient free space to record depth and bathymetry data.

When using RealBathy™, new contour lines are drawn in real time on the screen based on your transducer's depth readings. Color shading is used to reflect depth, with darkest shade signifying the shallowest area. The sonar data is recorded to the inserted memory card.

Setting up and creating RealBathy contours

To enable creation of RealBathy™ bathymetric contours in real time follow the steps below:

Important:

- You will need to know the distance above the bottom face of your transducer to the waterline.
- For tidal environments LightHouse™ NC2 cartography is required that includes tide station information for your location.

From the chart app.

1. Insert your LightHouse™ NC2 chart card into the display's card reader.
2. Select your LightHouse™ chart card as your cartography for the chart app.

For details on choosing your cartography refer to: [Selecting a chart card](#)

3. Enter the distance above the bottom face of your transducer to the waterline in the **Waterline to tdc** setting field.
4. Enable the **RealBathy** toggle switch, located in the **Depths** menu: **Menu > Depths**
5. Select the relevant **Height correction** option:
 - **None** — No corrections are made.
 - **Tidal** — Uses nearby tide station data to correct height. When **Tidal** is selected a tidal station search is performed and a list of available stations is displayed. Select the closest tide station to your location.

- **Lake level** — User specified value using the water level marker for your location.

Note:

To ensure accurate contour depths it is recommended that:

- in tidal environments (e.g.: seas and oceans) you use LightHouse™ NC2 cartography that includes tide station information and select the tide station closest to your location, or
- in fresh water environments (e.g.: lakes) select **Lake level** in the **Height correction:** field and then enter the current reading from the water level marker for your location into the field located under the height correction option.

6. Adjust the **Visibility:** setting to the desired transparency.

100% provides full visibility of the RealBathy contours, as the percentage decreases the chart detail behind the RealBathy contours becomes more visible.

7. Select the required **Density:** setting.

Steep drop-offs can result in overlapping contour lines, lowering the density in these situations provides a clearer view.

7.5 Chart settings menu

The table below lists settings applicable to the chart app and their location within the app's **Settings** menu. Available settings are dependent on the cartography in use. If a setting is not displayed then the feature is not compatible with your cartography. If a feature is grayed out then it requires a subscription to activate the feature.

Cartography tab

Description	Options
Allows you to select the cartography that you want to use in the current Chart app.	<ul style="list-style-type: none"> • LightHouse Charts • Navionics • C-MAP

Set-up tab

Menu item and description	Options
<p>Chart detail: Allows you to select the level of detail displayed onscreen for vector based cartography. This setting is always available and not dependent on the cartography in use.</p>	<ul style="list-style-type: none"> • Low • Medium • High
<p>Chart motion: Chart motion controls how the chart and boat are drawn in relation to each other. This setting is always available and not dependent on the cartography in use.</p>	<ul style="list-style-type: none"> • Relative motion • True motion • Auto range
<p>Chart orientation: The orientation of the chart affects the alignment of the chart relative to either your vessel heading, your course or North. This setting is always available and not dependent on the cartography in use.</p>	<ul style="list-style-type: none"> • North-up • Head-up • Course-up
<p>Boat icon: The icon used to represent your vessel can be customized to better reflect your vessel. This setting is always available and not dependent on the cartography in use.</p>	<ul style="list-style-type: none"> • Inboard Speed Boat • Outboard Speed Boat • Power Cruiser • Pro Fishing • RIB • Kayak • Pontoon
<p>Icon type: The type of icon used to represent your vessel can be customized. This setting is always available and not dependent on the cartography in use.</p>	<ul style="list-style-type: none"> • Icon (large) • Icon (small) • Outline • Teardrop
<p>Boat position Adjust the boat position to allow more or less 'look ahead' space in front of your boat. This setting is always available and not dependent on the cartography in use.</p>	<ul style="list-style-type: none"> • Center • Partial offset • Full offset
<p>Tide animation interval Allows you to select the time interval used for the tide and current animations. This setting is always available and not dependent on the cartography in use.</p>	<ul style="list-style-type: none"> • 15 minutes to 2 hours in 15 minute steps.

Menu item and description	Options
<p>Auto enter RUNNING mode: When enabled the Chart app will automatically switch to running mode when vessel speed exceeds 10 knots, the chart app will automatically switch to the previously used mode when vessel speed drops below 10 knots. This setting is always available and not dependent on the cartography in use.</p>	<ul style="list-style-type: none"> • On • Off
<p>Aerial Enables and disables display of a photographic aerial overlay. This setting is available when using C-MAP® or Navionics® cartography.</p>	<ul style="list-style-type: none"> • On • Off
<p>Coverage: Determines where the aerial overlay will be used. This setting is available when using Navionics® cartography.</p>	<ul style="list-style-type: none"> • Land only • Land and sea • Land and shallow
<p>Tides Enables and disables display of Tide and Current graphics at tide and current stations. This setting is available when using Navionics® cartography.</p>	<ul style="list-style-type: none"> • On • Off
<p>Community edits Enables and disables display of crowd sourced data. This setting is available when using Navionics® cartography.</p>	<ul style="list-style-type: none"> • On • Off
<p>High res bathy Enables and disables display of High Resolution Bathymetry charts which provides improved bottom detail, contours and structure. This setting is available when using C-MAP® cartography.</p>	<ul style="list-style-type: none"> • On • Off
<p>Sports fishing Allows you to display easy-to-use information pages about fishing locations including fish type, size, depth and reef and bottom composition. This setting is available when using C-MAP® cartography.</p>	<ul style="list-style-type: none"> • On • Off
<p>Navigation mark symbols: Determines whether International or US navigation mark symbols are used. This setting is always available and not dependent on the cartography in use.</p>	<ul style="list-style-type: none"> • US • International

Depths tab

Menu item and description	Options
<p>Shallow area: Enables and disables identification of areas deemed to be shallow. When enabled, a red hatched area is displayed in areas deeper than the depth specified in the Zero to field.. This setting is available when using Navionics® cartography.</p>	<ul style="list-style-type: none"> • On • Off
<p>Zero to: Specifies the depth used for the Shallow area setting. This setting is available when using Navionics® cartography.</p>	0 ft to 60 ft (or equivalent units)
<p>Deep contour: Determines the depth at which the deep water color applies. This setting is always available and not dependent on the cartography in use.</p>	Numeric depth value.

Menu item and description	Options
<p>Deep water color Allows you to specify the color used to identify deep water. This setting is always available and not dependent on the cartography in use.</p>	<ul style="list-style-type: none"> • White • Blue
<p>Record depth data Enables depth and position data to be recorded to memory card This setting is available when using LightHouse™ charts.</p>	<ul style="list-style-type: none"> • On • Off
<p>SD card: When a suitable MicroSD card has been inserted the free space available for recording depth data and RealBathy is displayed. This setting is available when using LightHouse™ charts.</p>	N/A
<p>Waterline to tdc: Enter the distance between the waterline and your depth transducer. This setting is available when using LightHouse™ charts.</p>	0 ft to 9.9 ft
<p>RealBathy: Displays previously recorded RealBathy™ data saved on memory card on the chart. This setting is available when using LightHouse™ charts.</p>	<ul style="list-style-type: none"> • On • Off
<p>Visibility: Determines the transparency of the RealBathy data and SonarChart live data displayed onscreen. This setting is available when using LightHouse™ charts or Navionics® cartography.</p>	<ul style="list-style-type: none"> • 0% to 100%
<p>Height correction: Determines the level of height correction applied to RealBathy and depth data. This setting is available when using LightHouse™ charts.</p>	<ul style="list-style-type: none"> • None • Tidal • Lake level
<p>Safety depth shading: Determines the depth at which the Safety contour is displayed. This setting is available when using LightHouse™ vector charts.</p>	Numeric value
<p>Density Selects the density of available depth contours. This setting is available when using LightHouse™ charts or Navionics® cartography.</p> <div data-bbox="165 1451 975 1579" style="border: 1px solid black; padding: 5px;"> <p>Note: The 'Very high' option is only available when using Navionics cartography.</p> </div>	<ul style="list-style-type: none"> • Low • Medium • High • Very high
<p>Sonar logging Allows logging of depth and position data to your Navionics chart card. This setting is available when using Navionics® cartography.</p>	<ul style="list-style-type: none"> • On • Off
<p>SonarChart Live Enables and disables Navionics SonarChart Live feature which enables real time creation and display of high resolution bathymetry charts. This setting is available when using Navionics® cartography.</p>	<ul style="list-style-type: none"> • On • Off
<p>Tide correction Enables Sonar logging depth measurements to be offset by tide height data from nearby tide stations. This setting is available when using Navionics® cartography.</p>	<ul style="list-style-type: none"> • On • Off

Menu item and description	Options
<p>Fishing Zone: You can set up a Fishing zone by enabling Fishing zone and specifying a minimum depth and maximum depth. Areas on the chart that are between these depths will be colored White, areas outside of these depths will be colored Blue. This setting is available when using Navionics® cartography.</p>	<ul style="list-style-type: none"> • On • Off
<p>2D shading Enables and disables 2D shading. This setting is available when using Navionics® cartography.</p>	<ul style="list-style-type: none"> • On • Off

Databoxes tab

Settings	Description
1:	Determines the data item displayed in databox 1.
2:	Determines the data item displayed in databox 2.
3:	Determines the data item displayed in databox 3.
4:	Determines the data item displayed in databox 4.
Reset all	Selecting will reset all databoxes to factory defaults.

7.6 SonarChart™ Live

You can create personal bathymetry charts using your depth transducer and the SonarChart™ Live feature, available with compatible Navionics® electronic cartography cards.

Note: Before using SonarChart™ Live ensure you have correctly configured your transducer depth settings.

When using SonarChart™ Live, new contour lines are drawn in real time on the screen based on your transducer's depth readings. Color shading is used to reflect depth, with dark red signifying the shallowest area. The sonar data is recorded to your cartography card and is shared with Navionics when you update your chart card online.

Tide correction

SonarChart™ Live records the actual readings from your depth transducer under current tide / water level conditions. You can enable automatic adjustment of depth readings based on normalized low tide / low water level depth data taken from a nearby Tide station.

Enabling SonarChart Live

To enable creation of real time SonarChart™ Live bathymetry lines:

With your transducer depth settings correctly configured and compatible cartography selected:

1. Select the **Depth** tab from the Chart app settings menu: **Chart app > Menu > Settings > Depth**.
2. Enable **Sonar logging**.
3. Enable **SonarChart Live**.
4. Select the **Visibility** setting field, and adjust to your preferred value.
5. If required, enable **Tide correction**.

Chapter 8: Fishfinder app

Chapter contents

- 8.1 Fishfinder app overview on page 92
- 8.2 Fishfinder channels on page 95
- 8.3 Placing a Waypoint in the Fishfinder app on page 96
- 8.4 Sonar scroll back on page 97
- 8.5 Fishfinder sensitivity controls on page 98
- 8.6 Configuring transducer settings on page 99
- 8.7 Fishfinder settings menu on page 100

8.1 Fishfinder app overview

The Fishfinder app displays a visualization of the echoes received from your connected transducer and builds an underwater scrolling view of bottom structure and targets that pass under your transducer.

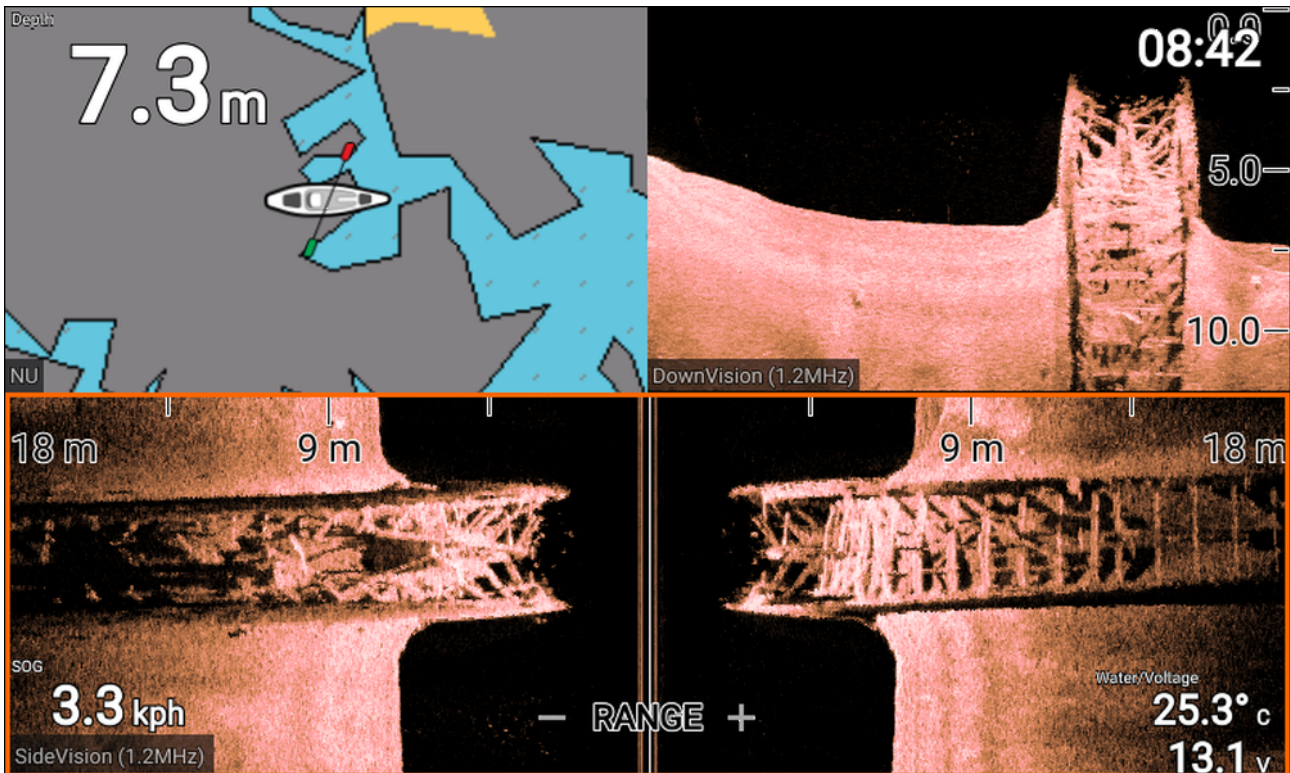

For each instance of the Fishfinder app you can select which channel you want to use. Channel selection will persist over a power cycle.

Fishfinder app controls

The Fishfinder app has 2 control modes, Scrolling mode and Pause / Playback mode. The behavior of some controls are dependent upon control mode and also the Fishfinder channel being displayed. The following controls apply to DownVision™, SideVision™ and Conical sonar channels. The controls below do not apply to RealVision™ channels.

Scrolling mode

Scrolling mode is the default mode when the Fishfinder app is opened. In Scrolling mode an image is displayed which scrolls from right to left across the screen.

Control behavior:

- Pressing the **Plus** button will switch to Zoom mode.
- When in Zoom mode pressing the **Plus** or **Minus** buttons will increase and decrease the zoom level.
- Pressing the **OK** button displays the onscreen gain controls on the left side of the screen.
- Pressing the **Waypoint** button will place a Waypoint at your vessels's current location.
- Pressing the **Menu** button will open the app menu.
- Pressing any button on the **Directional pad** will switch to Pause / Playback mode.

Pause / Playback mode

In Pause / Playback mode the image is temporarily paused and the cursor can be moved around the screen.

Control behavior:

- Pressing the **Plus** button will switch to Zoom mode and the scrolling image remains paused.
- When in Zoom mode pressing the **Plus** or **Minus** buttons will increase and decrease the zoom level.
- Pressing the **OK** button displays the Fishfinder context menu.
- Pressing the **Waypoint** button will place a Waypoint at the cursor's location.
- Pressing any button on the **Directional pad** will move the cursor in that direction.

- With the cursor at the far left of the screen, continuing to press the Left button will display the scrolling image history, which enables you to view structure and targets you have already passed.
- Pressing the **Menu** or **Back** button will return the Fishfinder app to scrolling mode.

RealVision™ app controls

When viewing RealVision™ channels the controls behave differently to other Fishfinder channels.

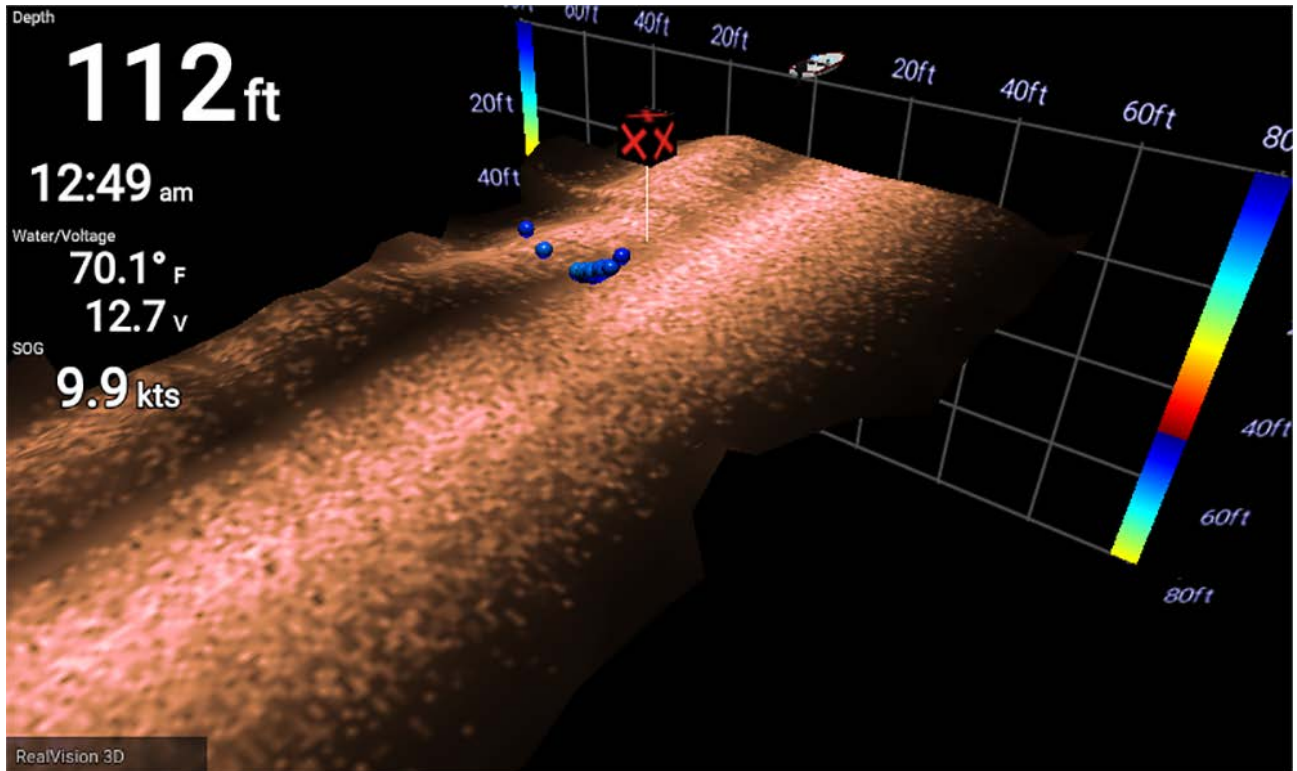

Scrolling mode

Scrolling mode is the default mode when the Fishfinder app is opened. In Scrolling mode an image is displayed which scrolls across the screen.

Control behavior:

- Pressing the **Plus** or **Minus** buttons will increase and decrease the zoom level.
- Pressing any button on the **Directional pad** will rotate the image in the respective direction.
- Pressing the **Waypoint** button will place a Waypoint at your vessels's current location.
- Pressing the **Menu** button will open the app menu.
- Pressing the **OK** button pauses scrolling and switches to Pause / Playback mode.

Pause / Playback mode

In Pause / Playback mode the image is paused and the cursor can be moved around the screen.

Control behavior:

- Pressing the **Plus** or **Minus** buttons will increase and decrease the zoom level.
- Pressing the **OK** button displays the Fishfinder context menu.
- Pressing the **Waypoint** button will place a Waypoint at the cursor's location.
- Pressing any button on the **Directional pad** will move the cursor in that direction.
- With the cursor positioned at the opposite edge of the screen to the vessel icon, continuing to move the cursor in the same direction will display the scrolling image history, which enables you to view structure and targets you have already passed.
- Pressing the **Menu** button will return the Fishfinder app to scrolling mode and open the app menu.
- Pressing the **Back** button will return the Fishfinder app to scrolling mode.

Opening the Fishfinder app

Select an app page icon from the homescreen that includes the Fishfinder app.

Pre-requisites:

1. Ensure your transducer is compatible (check the latest details available on the Raymarine website). If in doubt please contact an authorized Raymarine dealer for advice.
2. Ensure you have installed and connected your transducer in accordance with its supplied documentation.

When opened the Fishfinder app will scroll across the screen, displaying target returns of objects and bottom structure that has passed under your transducer.

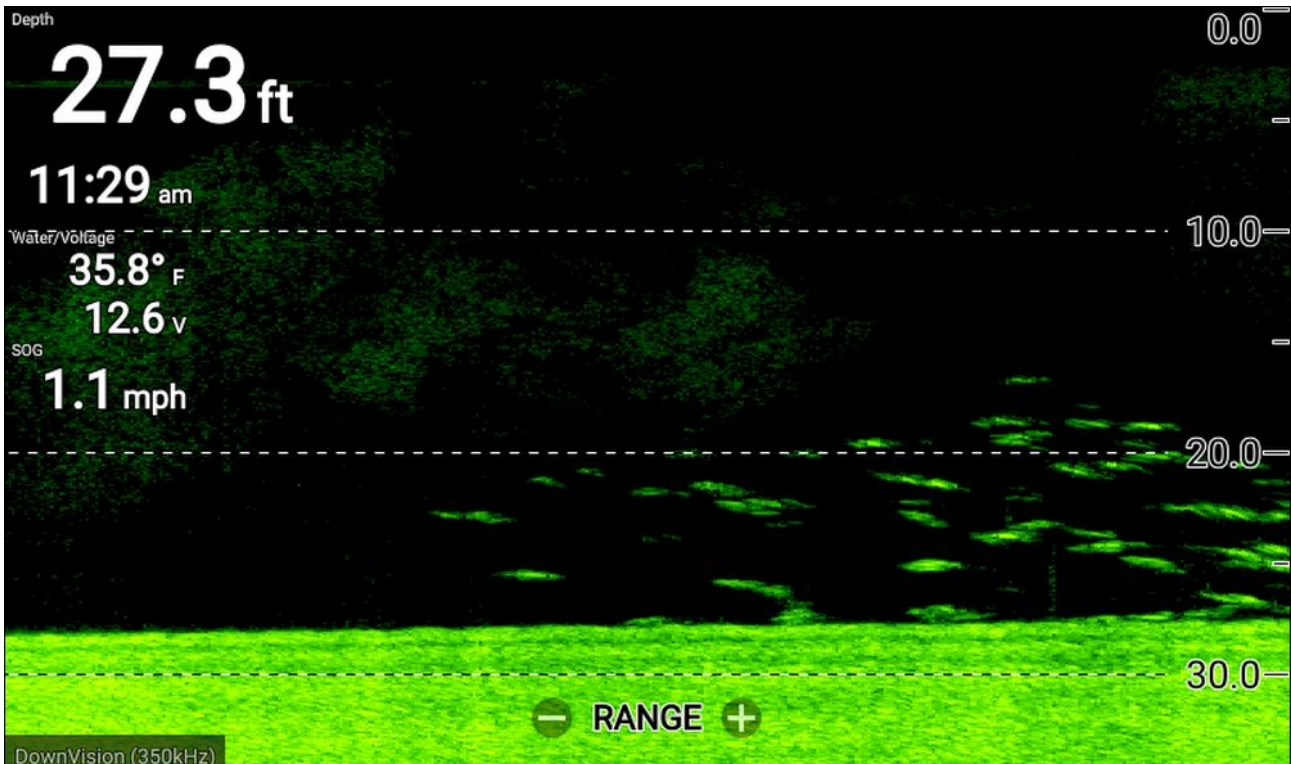

If the **'No transducer connected'** warning is displayed then your transducer has not been detected.

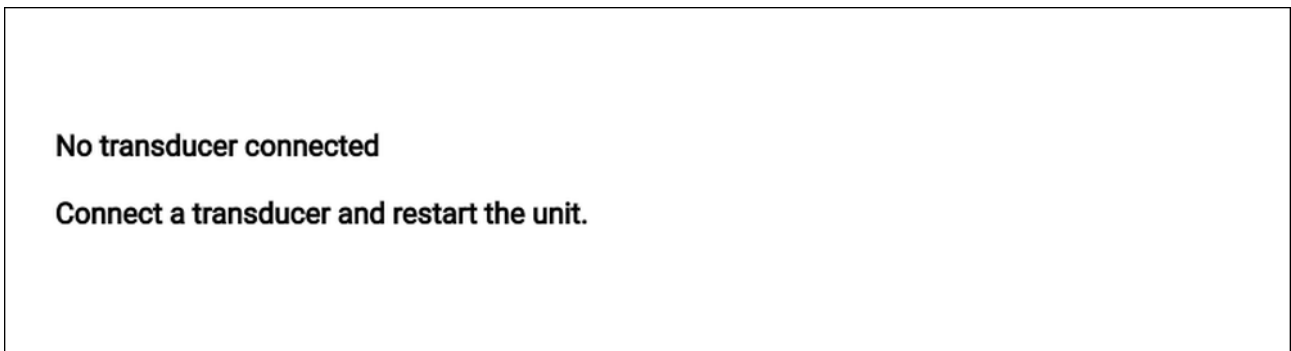

Check your transducer connection(s) are correct and free from damage, then power cycle your display. If the transducer is still not found then refer to your transducer's installation documentation for further troubleshooting information.

8.2 Fishfinder channels

The following Fishfinder channels are available.

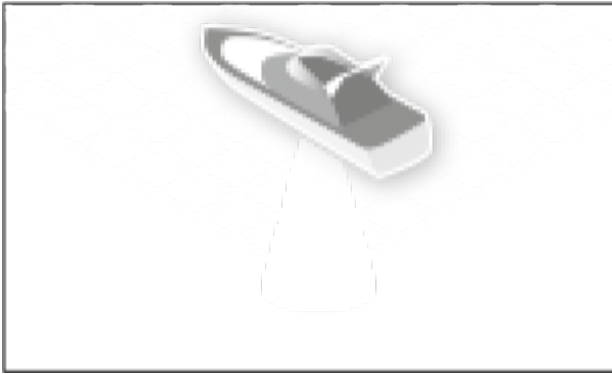

RealVision™ 3D (350 kHz / 1.2 MHz)

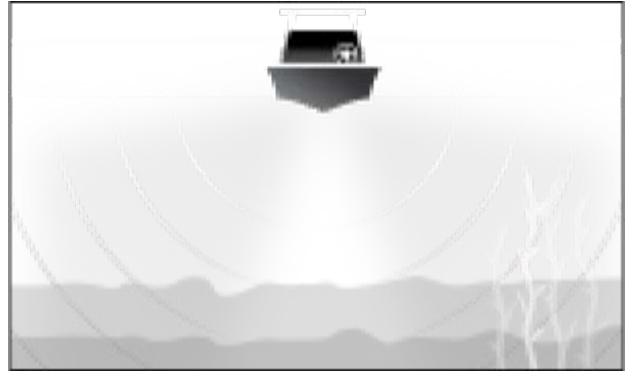

SideVision™ (350 kHz / 1.2 MHz)

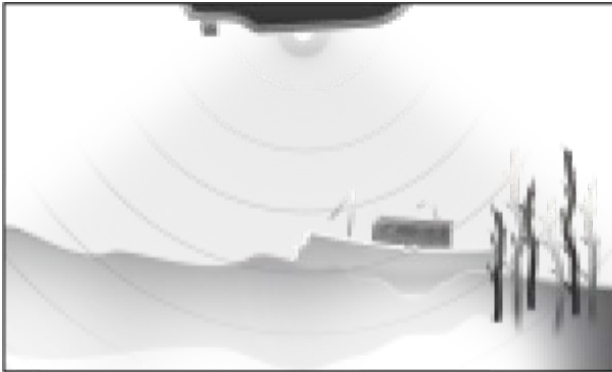

DownVision™ (350 kHz / 1.2 MHz)

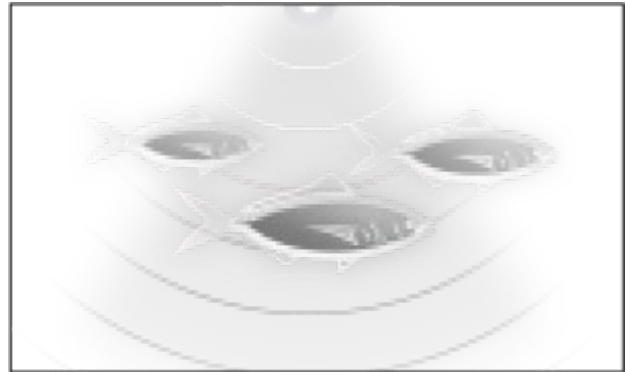

Conical high CHIRP
(200 kHz)

To view a sonar channel select the relevant icon from the app menu.

Switching channel frequency

DownVision™, SideVision™ and RealVision™ channels are available in both 350 kHz (Standard) and 1.2 MHz (Hyper) frequencies.

With a dual frequency channel displayed:

1. Press the **Menu** button.
2. Select the **Freq:** option.
3. Select either **Standard (350 kHz)** or **HyperVision (1.2 MHz)** as required.

HyperVision™ channels provide higher resolution than standard channels with reduced range.

8.3 Placing a Waypoint in the Fishfinder app

When you observe something of interest in the Fishfinder app you can place a waypoint at its location so that you can find the area again.

1. Use the **Directional pad** to highlight a point of interest onscreen.

Scrolling is paused, temporarily.

2. Press the **Waypoint** button and, if required enter relevant waypoint details.

Scrolling will resume automatically if no buttons are pressed for approximately 15 seconds.

8.4 Sonar scroll back

You can “scroll back” in the Fishfinder app to playback sonar history when the Fishfinder app is in Pause / Playback mode.

To activate pause / playback mode:

- **Sonar / DownVision / SideVision** — Press any **Directional pad** button.
- **RealVision 3D** — Press the **OK** button.

In pause / playback mode the **Scroll back bar** is displayed.

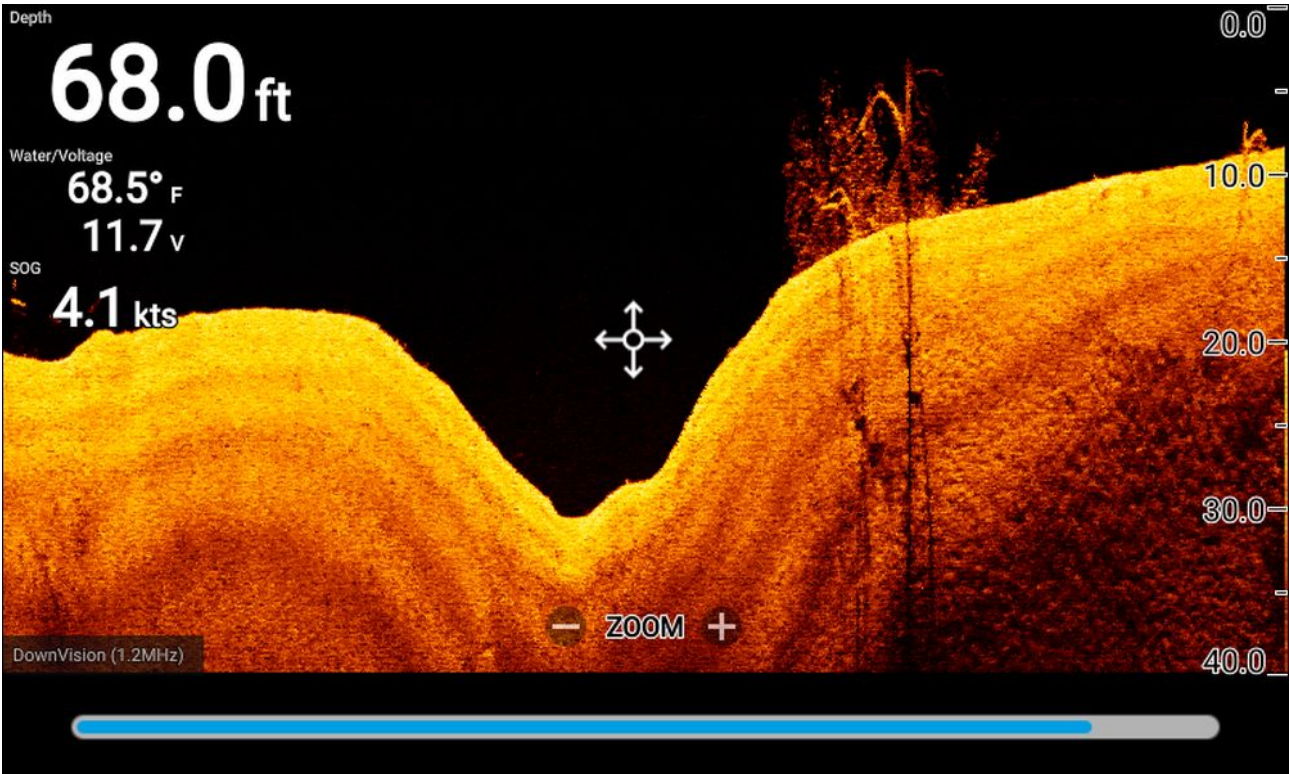

The scrolling image can be played back from any point since the fishfinder app was opened.

Playing back sonar history

The fishfinder app's sonar history can be played back.

With the fishfinder app in scrolling mode:

1. Press any button on the **Directional pad** or press the **OK** button when viewing a RealVision channel.
The fishfinder app will enter Pause / playback mode.
2. Using the **Directional pad**, move the cursor in the same direction that the image is scrolling, until you reach the edge of the screen.





*e.g.: when viewing a DownVision channel use the **Left** button on the **Directional pad** to position the cursor on the left edge of the screen, continue to press the **Left** button to start scrolling back through the available sonar history.*

8.5 Fishfinder sensitivity controls

Optimum performance is usually achieved using the default settings. You can adjust the image using the Sensitivity controls to improve the displayed image. Sensitivity setting adjustment is also applied to the sonar history that is displayed when using sonar scroll back.

The sensitivity controls can be accessed from the fishfinder app menu: **Menu > Adjust sensitivity.**

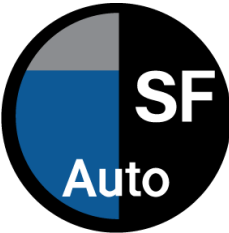
The following sensitivity controls are available to help you optimize the sonar image.

Control	Description
	<p>Gain The gain control determines the signal strength at which target returns are shown onscreen. The gain control can be set to Auto or Manual. In Auto you can apply an offset of up to $\pm 50\%$. A higher value produces more target returns and noise onscreen.</p>
	<p>Intensity The intensity control sets the lower limit for the color used for the strongest target returns. All target returns above this value are displayed in the strongest color. Those with a weaker value are divided equally between the remaining colors. The intensity control can be set to Auto or Manual. In Auto you can apply an offset of up to $\pm 50\%$.</p>
	<p>Surface Filter The surface filter control determines the amount of noise displayed onscreen by varying the gain throughout the water column. A lower value decreases the depth at which the control is applied. The control can be set to Auto or Manual.</p>
	<p>All to Auto Sets all Sensitivity controls to Auto with 0% offset, where applicable.</p>

8.6 Configuring transducer settings

For systems set up with a transducer connected, as part of setting up your system for the first time it is important that you correctly set up your transducer.

Transducer configuration settings are available from the **Fishfinder app**.

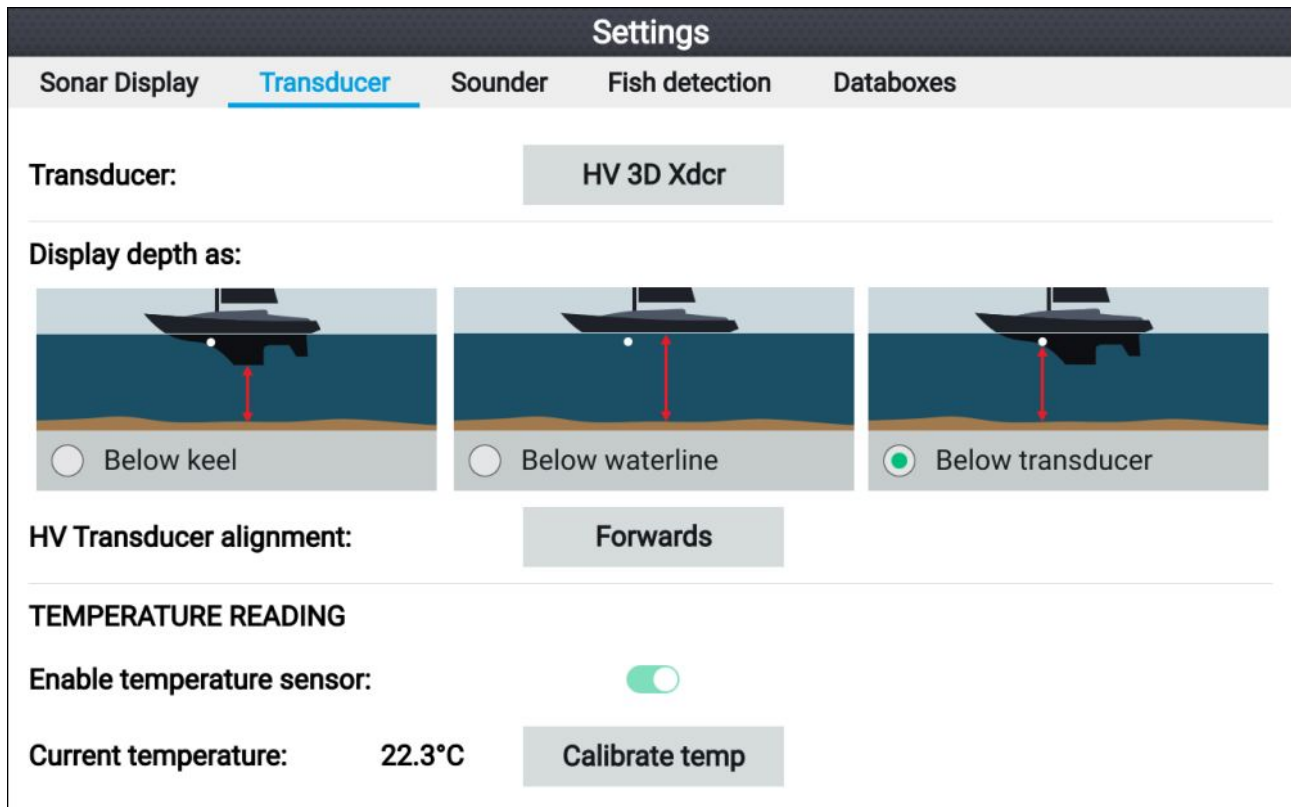

1. Select **Transducer** from the Fishfinder app's **Settings** menu: **Menu > Settings > Transducer**
2. If your installation required you to install an all-in-one transducer backwards (e.g.: this may occur when connecting the transducer to a trolling motor), then select **Backwards** from the **HV transducer alignment** option. This ensures that the port and starboard channels appear correctly orientated onscreen, otherwise keep the default setting: **Forwards**.
3. Select where you want your depth measurements taken from:
 - i. Below transducer (default) — No offset required
 - ii. Below keel — Enter the distance between the transducer face and the bottom of the keel.
 - iii. Below waterline — Enter the distance between the bottom of your keel and the waterline.
4. You can configure temperature settings as follows:
 - i. Enable or disable temperature readings as required.
 - ii. If enabled, check the temperature reading against the actual water temperature.
 - iii. If the current reading requires adjustment, select **Calibrate temp** and enter the difference between your 2 readings.

8.7 Fishfinder settings menu

The table below details the settings available in the fishfinder app.

<p>Note:</p> <p>The availability of some fishfinder settings are dependent on the fishfinder channel being viewed.</p>

Sonar display tab — RealVision™ 3D

Menu item and description	Options
<p>Boat icon Choose which boat icon to use.</p>	List of available boat icons.
<p>Target colors Changes the color palette used for target returns.</p>	<ul style="list-style-type: none"> • Rainbow (default) • Burnt Yellow • Cool Blue • Lime Green • Ruby Red
<p>Color targets by Changes the way targets are colored. Depth colors targets according to their depth, a gradient scale can be shown on the 3D grid to aid depth identification. Intensity colors targets according to their size, the bigger the target the darker the color used.</p>	<ul style="list-style-type: none"> • Depth (default) • Intensity
<p>Bottom colors Changes the color used for bottom structure.</p>	<ul style="list-style-type: none"> • Copper • Inv Copper • Slate Gray • Lime Green • Inv Lime Green • Burnt Yellow (default) • Inv Burnt Yellow • Cool Blue • Inv Cool Blue • Ruby Red
<p>Background Changes the color used for the app background.</p>	<ul style="list-style-type: none"> • Black (default) • Blue • White • Gray
<p>Target size Determines the size that target returns will appear onscreen. The higher the number the larger the target returns appear.</p>	Value between 0 to 25 (5 (default))

Sonar display tab (SideVision channel)

Menu item and description	Options
<p>Color palette Various color palettes are available to suit different conditions or your personal preference.</p>	<ul style="list-style-type: none"> • Copper • Inv Copper • Slate Gray • Lime Green • Inv Lime Green • Burnt Yellow (default) • Inv Burnt Yellow • Cool Blue • Inv Cool Blue • Ruby Red
<p>Range lines Displays vertical range lines onscreen.</p>	<ul style="list-style-type: none"> • On • Off (default)
<p>Color threshold Color threshold determines the signal strength below which target returns are not shown. A low value results in only the strongest colors or lightest shades being displayed.</p>	Value between 0% to 100%.(100% (default))
<p>Scroll speed Determines the scrolling speed for the Sonar image.</p>	Value between 0% to 500% (100% (default)).

Sonar display tab (DownVision channel)

Menu item and description	Options
<p>Color palette: Various color palettes are available to suit different conditions or your personal preference.</p>	<ul style="list-style-type: none"> • Copper • Inv Copper • Slate Gray • Lime Green • Inv Lime Green • Burnt Yellow (default) • Inv Burnt Yellow • Cool Blue • Inv Cool Blue • Ruby Red
<p>Depth lines: Displays horizontal depth lines.</p>	<ul style="list-style-type: none"> • On • Off (default)
<p>Temperature graph: When enabled overlays a temperature line on the scrolling sonar image. The temperature line will help to determine change in water surface temperature. In Pause / playback mode temperature labels are displayed on the temperature line.</p>	<ul style="list-style-type: none"> • On • Off (default)
<p>Manual temp range: When enabled you can specify a fixed manual minimum and maximum limit for water surface temperature. The Maximum and Minimum limits are displayed in the temperature graph. The temperature graph overlay must be enabled before manual temperature range can be enabled.</p>	<ul style="list-style-type: none"> • On • Off (default)

Menu item and description	Options
Maximum temp: Specifies the fixed maximum water temperature limit for the temperature graph.	Temperature value.
Current temp: Displays the temperature currently being recorded by your transducer's temperature sensor.	Temperature value.
Minimum temp: Specifies the fixed minimum water temperature limit for the temperature graph.	Temperature value.
Beep: When manual temperature range has been selected the display can trigger an audible beep when the current temperature reading passes the minimum and maximum temperature thresholds.	<ul style="list-style-type: none"> • On • Off (default)
Color threshold Color threshold determines the signal strength below which target returns are not shown. A low value results in only the strongest colors or lightest shades being displayed.	Value between 0% to 100%.(100% (default))
Scroll speed Determines the scrolling speed for the Sonar image.	Value between 0% to 500% (100% (default)).

Sonar display tab (High CHIRP sonar channel)

Menu item and description	Options
Color palette Various color palettes are available to suit different conditions or your personal preference.	<ul style="list-style-type: none"> • Classic Blue (default) • Classic Black • Classic White • Sunburst • Grayscale • Inv. Grayscale • Copper • Night Vision
A-scope A-Scope mode provides a splitscreen view that includes the normal scrolling sonar image and a smaller pane which shows a 'live' image of what is directly below your transducer.	<ul style="list-style-type: none"> • Off (default) • Center • Right • Cone
Depth lines Displays horizontal depth lines.	<ul style="list-style-type: none"> • On • Off (default)
White line Displays a solid white line along the detected bottom contour.	<ul style="list-style-type: none"> • On • Off (default)
Bottom fill Fills the area below the detected bottom contour with a solid color.	<ul style="list-style-type: none"> • On • Off (default)
Temperature graph: When enabled overlays a temperature line on the scrolling sonar image. The temperature line will help to determine change in water surface temperature. In Pause / playback mode temperature labels are displayed on the temperature line.	<ul style="list-style-type: none"> • On • Off (default)

Menu item and description	Options
<p>Manual temp range: When enabled you can specify a manual minimum and maximum limit for water surface temperature. The temperature graph overlay must be enabled before manual temperature range can be enabled.</p>	<ul style="list-style-type: none"> • On • Off (default)
<p>Maximum temp: Specifies the fixed maximum water temperature limit for the temperature graph.</p>	Temperature value.
<p>Current temp: Displays the temperature currently being recorded by your transducer's temperature sensor.</p>	Temperature value.
<p>Minimum temp: Specifies the fixed minimum water temperature limit for the temperature graph.</p>	Temperature value.
<p>Beep: When manual temperature range has been selected the display can trigger an audible beep when the current temperature reading passes the minimum and maximum temperature thresholds.</p>	<ul style="list-style-type: none"> • On • Off (default)
<p>Color threshold Color threshold determines the signal strength below which target returns are not shown. A low value results in only the strongest colors or lightest shades being displayed.</p>	Value between 0% to 100%.(100% (default))
<p>Scroll speed Determines the scrolling speed for the Sonar image.</p>	Value between 0% to 500% (100% (default)).

Transducer tab

Menu item and description	Options
<p>Transducer: Displays the type of connected transducer.</p>	N/A
<p>Display depth as: Determines the position from where depth readings are taken.</p>	<ul style="list-style-type: none"> • Below keel • Below waterline • Below transducer (default)
<p>HV transducer alignment: You can select which orientation your HyperVision™ transducer has been installed in. E.g.: if you have installed the transducer on a trolling motor, the transducer may have been installed with the bow arrow pointing towards the stern of the trolling motor instead of the bow. Forwards should be selected if the transducer's bow arrow is pointing towards the bow. Backwards should be selected if the transducer's bow arrow is pointing towards the stern.</p>	<ul style="list-style-type: none"> • Forwards (default) • Backwards
<p>Enable temperature sensor: Enables and disables the selected transducer's temperature sensor.</p>	<ul style="list-style-type: none"> • On • Off
<p>Current temperature: Displays the transducer's current temperature reading.</p>	N/A
<p>Calibrate temp Allows you to enter an offset between the actual measured water temperature and the current temperature displayed by your transducer.</p>	Offset temperature value.

Sounder tab

Menu item and description	Options
Ping enable: Enables and disables transducer ping.	<ul style="list-style-type: none"> • On (default) • Off
Ping rate limit: Allows you to restrict the transducer's maximum ping rate to suit current conditions.	Value between 1 and 100 (80 (default)).
Interference rejection Removes interference caused by other transducers on your vessel or from vessels equipped with transducers close by.	<ul style="list-style-type: none"> • Auto (default) • Low • Medium • High • Off
2nd echo rejection The control helps to remove false target returns or false bottom that can be caused by signal reflection.	<ul style="list-style-type: none"> • Off • Low (default) • High
Reset sounder Resets the sonar module to factory default settings.	<ul style="list-style-type: none"> • Yes • No

Note:
The fish detection tab is only available when viewing a high CHIRP sonar channel.

Fish detection tab

Menu item and description	Options	
Fish detection beep: Enables and disables audible beep when a target is detected that is considered to be a fish.	<ul style="list-style-type: none"> • On • Off (default) 	
Fish icons: Enables and disables display of a fish icon over targets considered to be fish.	<ul style="list-style-type: none"> • On • Off (default) 	
Fish depth labels: Enables and disables display of depth labels next to targets considered to be fish.	<ul style="list-style-type: none"> • On • Off (default) 	
Detection sensitivity: Determines how sensitive the fish detection algorithm is. The higher the value, the more target returns will be considered to be fish.	Values from 0 to 100 (75 (default)).	
Ignore fish shallower than: Targets returns found in water shallower than the specified depth will not be considered to be fish.	0 ft to 1000 ft (3.3 ft (default)) or equivalent units.	
<table border="1" style="width: 100%;"> <tr> <td> Note: The shallow limit cannot be greater than the deep limit. </td> </tr> </table>	Note: The shallow limit cannot be greater than the deep limit.	
Note: The shallow limit cannot be greater than the deep limit.		
Ignore fish deeper than: Targets returns found in water deeper than the specified depth will not be considered to be fish.	0 ft to 1000 ft (984 ft (default)) or equivalent units.	
<table border="1" style="width: 100%;"> <tr> <td> Note: The deep limit cannot be less than the shallow limit. </td> </tr> </table>	Note: The deep limit cannot be less than the shallow limit.	
Note: The deep limit cannot be less than the shallow limit.		

Databoxes tab

Description	Option
Determines the data item displayed in databox 1.	1:
Determines the data item displayed in databox 2.	2:
Determines the data item displayed in databox 3.	3:
Determines the data item displayed in databox 4.	4:
Selecting will reset all databoxes to factory defaults.	Reset all

Chapter 9: Dashboard app

Chapter contents

- [9.1 Dashboard app overview on page 108](#)

9.1 Dashboard app overview

The Dashboard app enables you to view system data. System data may be generated by your display or by devices connected to your display via SeaTalkng® / NMEA 2000.

Note: For data to be available in the Dashboard app it must be transmitted to your display from compatible hardware using supported protocols and messages.



D14424-1

You can configure which Data pages you want visible in the Dashboard app, the Data page selection will persist over a power cycle.

The Dashboard app is pre-configured with a number of customizable data pages.

Switching data page

When the Dashboard app is the active app you can cycle through the available data pages.

1. Use the **Left** and **Right** buttons to cycle through the available data pages.

Alternatively, you can select a page you want to display using the page icons found in the app menu.

Hiding and showing data pages

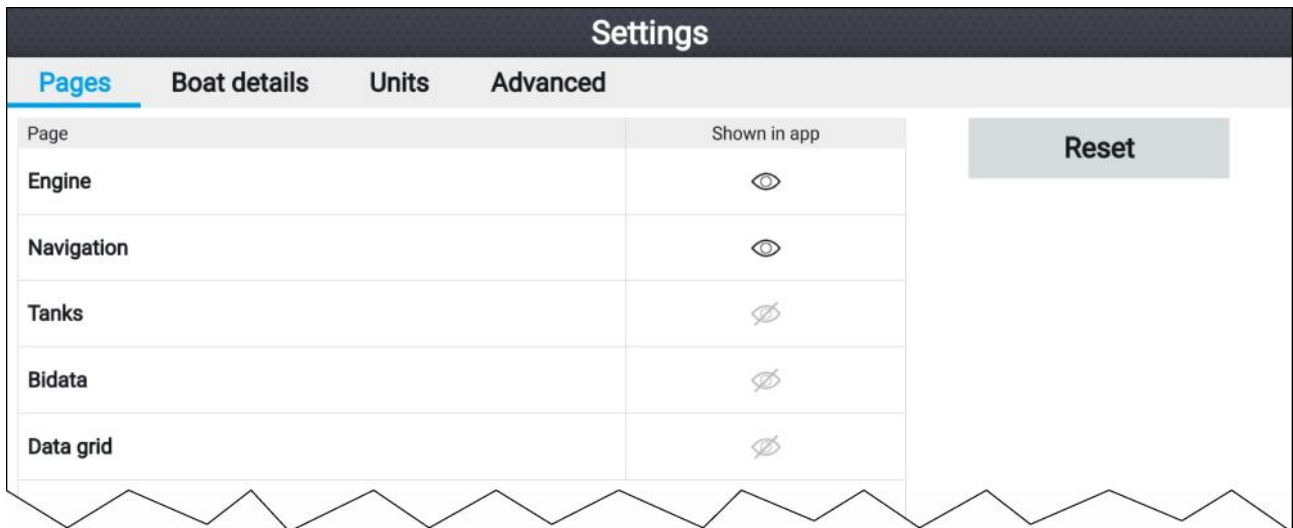

With the dashboard app displayed and active:

1. Press the **Menu** button.
2. Select the **Settings** icon.
The menu is opened on the **Pages** tab.
3. Using the **Up** button and **Down** button, highlight the page you want to hide or show.
4. Press the **OK** button.
5. Select either **Hide page** or **Show page**.
6. Press the **Menu** button to close the menu.

Customizing existing data pages

The data items displayed on each page can be changed.

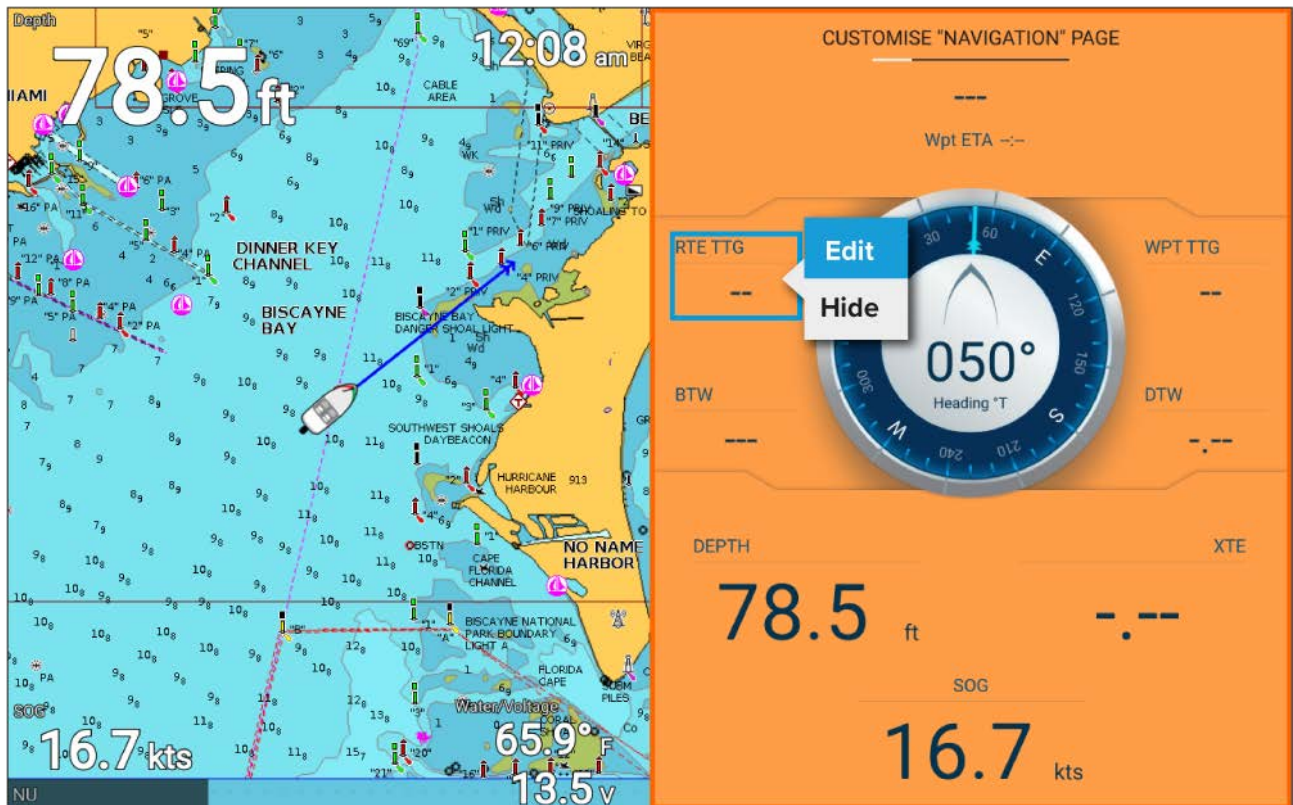

1. Select **Customize page** from the Dashboard app menu: **Menu > Customize page**.
2. Select the data item that you want to change.
3. Select **Edit** from the data item pop-over menu.
4. Select the new data item that you want to display.

Data items

The following data items can be displayed in Databoxes.

Note:
Where more than 1 data source is available for a data item, based on the specified Boat details (**Homescreen > Settings > Boat details**), then data items will be available for each data source.

Category	Data item
Battery <ul style="list-style-type: none"> • Battery 1 • Battery 2 • Battery 3 	<ul style="list-style-type: none"> • TTZ (Time To Zero) • SOC (State of Charge) • Batt. Temp. • Batt. Voltage • Batt. Current
Boat	<ul style="list-style-type: none"> • Fresh water 1 • Fresh water 2 • Live well 1 • Live well 2 • Gray water • Black water
Depth	<ul style="list-style-type: none"> • Depth
Display	<ul style="list-style-type: none"> • Supply voltage
Distance	<ul style="list-style-type: none"> • Trip season • Trip month • Trip day • Ground log
Engine <ul style="list-style-type: none"> • Port engine • Starboard engine • All engines 	<ul style="list-style-type: none"> • Engine load • RPM (Revolutions per minute) • Boost Pres. • Oil Temp. • Oil Pres. • Alternator • Coolant Pres. • Coolant Temp. • Engine trip hours • Engine hours • Fuel flow • Fuel flow (Inst) • Fuel rate (Avg) • Fuel Pres. • Gear • Trans. Oil Pres. • Trans. Oil Temp.

Category	Data item
Fuel <ul style="list-style-type: none"> • Tank 1 • Tank 2 • All Tanks 	<ul style="list-style-type: none"> • Engine economy total • Fuel flow total • Time to empty • Distance to empty • Fuel used (season) • Fuel used (trip) • Est. fuel remaining • Total fuel • Fuel level
Environment	<ul style="list-style-type: none"> • Max. water Temp. • Min water Temp. • Water Temp • Water / Voltage • Sunrise / Sunset
GPS	<ul style="list-style-type: none"> • COG (Course Over Ground) • Avg SOG (Speed Over Ground) • Max SOG • SOG • Position • COG SOG
Heading	<ul style="list-style-type: none"> • Heading
Navigation	<ul style="list-style-type: none"> • Rte ETA (Route Estimated Time of Arrival) • Rte TTG (Route Time To Go) • Wpt (Waypoint) • Wpt TTG • Wpt ETA • DTW (Distance To Waypoint) • XTE (Cross Track Error) • BTW (Bearing To Waypoint) • Waypoint info
Time	<ul style="list-style-type: none"> • Local Time • Local Date • Time and Timer

Dashboard app settings menu

Pages tab

Navigation	<p>The pop-over menu provides the following options:</p> <ul style="list-style-type: none"> • Hide page / Show page — When hidden the page will not be displayed in the dashboard app.
Tanks	
Bidata	
Data grid	

Engines	<ul style="list-style-type: none"> • Move up — Moves the page up in the page order. • Move down — Moves the page down in the page order. • Rename — Renames the page. <p>The data pages can be reset to factory defaults using the Reset button,</p>
----------------	---

Boat details

To ensure correct operation and display of data you should set the Boat Details settings according to your requirements.

Boat details can be accessed from the **Settings** menu: **Homescreen > Settings > Boat Details**

Option	Description
Min safe height:	Enter your vessel's maximum unladen height from the waterline. To ensure adequate clearance, it is recommended that you add a safety margin to this figure to allow for variation caused by vessel movements.
Min safe width:	Enter your vessel's maximum width at its widest point. To ensure adequate clearance on both sides, it is recommended that you add a safety margin for port and starboard to this figure to allow for variation caused by vessel movements.
Min safe depth:	Enter your vessel's maximum depth when fully laden. This is the depth from the waterline to the lowest point on the vessel's keel. To ensure adequate clearance, it is recommended that you add a safety margin to this figure to allow for variation caused by vessel movements.
Num of engines:	You can configure your system to display data for up to 2 engines, when connected to a compatible engine management system.
Identify engines:	Once you have selected the number of engines, select Identify engines and follow the onscreen instructions to configure your engines. May require an extra hardware interface to enable engine data to be displayed.
Fuel tanks:	You can configure your system to display data for up to 2 fuel tanks.
Fresh water tanks:	You can configure your system to display data for up to 2 fresh water tanks.
Live well tanks:	You can configure your system to display data for up to 2 Live well tanks.
Gray water tanks:	You can configure your system to display data for a Gray water tank.
Black water tanks:	You can configure your system to display data for a Black water tank.
Num of Batteries:	You can configure your system to display data for up to 3 batteries.

Units of measure

You can select your preferred units for data readings from the **Units** menu: **Homescreen > Settings > Units**.

Default units of measure are determined by the selected user interface language.

Measurement	Units
Distance units:	<ul style="list-style-type: none"> • Nautical Miles • NM & m • Statute Miles • Kilometers
Speed units:	<ul style="list-style-type: none"> • Kts • MPH • KPH

Measurement	Units
Depth units:	<ul style="list-style-type: none"> • Meters • Feet • Fathoms
Temperature units:	<ul style="list-style-type: none"> • Celsius • Fahrenheit
Volume units:	<ul style="list-style-type: none"> • US Gallons • Imperial Gallons • Liters
Economy units:	<ul style="list-style-type: none"> • Distance per Volume • Volume per Distance • Liters per 100 km
Pressure units:	<ul style="list-style-type: none"> • Bar • PSI • Kilopascals
Date format:	<ul style="list-style-type: none"> • MM:DD:YYYY • DD:MM:YYYY • MM:DD:YY • DD:MM:YY
Time format:	<ul style="list-style-type: none"> • 12hr • 24hr
Time zone:	<ul style="list-style-type: none"> • UTC offsets

Advanced settings menu

Menu item and description	Options
<p>Maximum RPM: The maximum RPM (Revolutions Per Minute) field determines the maximum RPM value displayed on the engine dial. when set to auto the system decides the maximum RPM value.</p>	<ul style="list-style-type: none"> • Auto (default) • 3000RPM • 4000RPM • 5000RPM • 6000RPM • 7000RPM • 8000RPM • 9000RPM • 10000RPM
<p>Custom RPM red zone: When enabled the engine RPM dial will show a Red zone between the Custom RPM red zone and the value specified in the RPM red zone start value field.</p>	<ul style="list-style-type: none"> • On • Off (default)
RPM red zone start value	0 RPM to 10,000 RPM

Chapter 10: Troubleshooting

Chapter contents

- [10.1 Troubleshooting on page 116](#)
- [10.2 Power up troubleshooting on page 117](#)
- [10.3 GPS / GNSS troubleshooting on page 119](#)
- [10.4 Sonar troubleshooting on page 120](#)
- [10.5 Wi-Fi troubleshooting on page 122](#)

10.1 Troubleshooting

The troubleshooting information provides possible causes and corrective action required for common problems associated with installation and operation of your product.

Before packing and shipping, all Raymarine products are subjected to comprehensive testing and quality assurance programs. If you do experience problems with your product this section will help you to diagnose and correct problems in order to restore normal operation.

If after referring to this section you are still having problems with your product, please refer to the Technical support section of this manual for useful links and Raymarine Product Support contact details.

10.2 Power up troubleshooting

Product does not turn on or keeps turning off

Possible causes	Possible solutions
Blown fuse / tripped breaker.	<ol style="list-style-type: none"> 1. Check condition of relevant fuses and breakers and connections, replace if necessary. (Refer to the <i>Technical Specification</i> section of your product's installation instructions for fuse ratings.) 2. If fuse keeps blowing check for cable damage, broken connector pins or incorrect wiring.
Poor / damaged / insecure power supply cable / connections	<ol style="list-style-type: none"> 1. Check that the power cable connector is correctly orientated and fully inserted into the display connector and locked in position. 2. Check the power supply cable and connectors for signs of damage or corrosion, and replace if necessary. 3. With the display turned on, try flexing the power cable near to the display connector to see if this causes the unit to restart or lose power. Replace if necessary. 4. Check the vessel's battery voltage and the condition of the battery terminals and power supply cables, ensuring connections are secure, clean and free from corrosion. Replace if necessary. 5. With the product under load, using a multi-meter, check for high voltage drop across all connectors / fuses etc, and replace if necessary.
Incorrect power connection	The power supply may be wired incorrectly, ensure the installation instructions have been followed.

Product will not start up (restart loop)

Possible causes	Possible solutions
Power supply and connection	See possible solutions from the table above, entitled 'Product does not turn on or keeps turning off'.
Software corruption	<ol style="list-style-type: none"> 1. In the unlikely event that the product's software has become corrupted, try downloading and installing the latest software from the Raymarine website. 2. On display products, as a last resort, attempt to perform a 'Power on Reset'. Be aware that this will delete all settings / presets and user data (such as waypoints and tracks), and revert the unit back to factory defaults.

Performing a power on reset

As part of troubleshooting you may be requested to perform a power on reset.

<p>Important:</p> <p>Before performing a power on reset ensure you have backed up your settings and user data to a memory card.</p>
--

With the display powered off:

1. Press and hold the **Home** button.
2. Press and hold the **Power** button until the display beeps.
3. Let go of the **Power** button.
4. When the Raymarine logo appears, let go of the **Home** button.
5. Use the **Down** button to highlight **Wipe data/factory reset**.
6. Press the **OK** button.
7. Use the **Down** button to highlight **Yes**.
8. Press the **OK** button.

The display will now be reset to factory default settings and all user data will be removed. 'Data wipe complete' is displayed at the bottom of the screen when the reset is finished.

9. Ensure **Reboot system now** is highlighted.
10. Press the **OK** button.

10.3 GPS / GNSS troubleshooting

Potential problems with the GPS / GNSS receiver and possible causes and solutions are described here.

Problem	Possible causes	Possible solutions
“No Fix” status icon is displayed. or display keeps losing position fix.	Geographic location or prevailing conditions preventing satellite fix.	Check periodically to see if a fix is obtained in better conditions or another geographic location.
	Display in poor location. For example: <ul style="list-style-type: none">• Below decks.• Close proximity to transmitting equipment such as VHF radio.	Ensure the display has an unobstructed view of the sky.

Note:

A GPS / GNSS status screen is accessible from the display’s Homescreen. This provides satellite signal strength and other relevant information.

10.4 Sonar troubleshooting

Problems with the sonar and their possible causes and solutions are described here.

No transducer connected message displayed

Possible causes	Possible solutions
No transducer connected.	Connect a transducer and reboot the display.
Wrong transducer type selected during initial start up wizard.	<p>Try selecting a sonar channel:</p> <ol style="list-style-type: none"> 1. Press the Menu button. 2. Use the Up/Down buttons to highlight a sonar channel. 3. Press the OK button. <p>If the message persists and there is a transducer connected then there may be a transducer connection fault.</p>
Damaged connectors/cabling	<ol style="list-style-type: none"> 1. Check that the transducer connector pins on the back of the display are not bent or broken. 2. Check that the transducer cable connector is correctly orientated and fully inserted into the display connector and locked in position. 3. Check the condition of the transducer cabling and connectors for signs of damage or corrosion, and replace if necessary.

Scrolling image is not being displayed or is intermittent

Possible causes	Possible solutions
Damaged connectors/cabling	<ol style="list-style-type: none"> 1. Check that the transducer connector pins on the back of the display are not bent or broken. 2. Check that the transducer cable connector is correctly orientated and fully inserted into the display connector and locked in position. 3. Check the condition of the transducer cabling and connectors for signs of damage or corrosion, and replace if necessary.
Transducer damaged or fouled	Check the condition of the transducer ensuring it is not damaged and is free from debris/fouling, clean or replace as necessary.
Incompatible transducer fitted.	Ensure the connected transducer is compatible with your system.

No depth reading / lost bottom lock

Possible causes	Possible solutions
Transducer location	Check that the transducer has been installed in accordance with the instructions that were provided with the transducer.
Transducer angle	If the transducer angle is too great the beam can miss the bottom, adjust transducer angle and recheck.
Transducer kicked-up	If the transducer has a kick-up mechanism, check that it has not kicked up due to hitting an object.
Transducer damaged or fouled	Check the condition of the transducer ensuring it is not damaged and is free from debris/fouling, clean or replace as necessary.

Possible causes	Possible solutions
Damaged connectors/cabling	<ol style="list-style-type: none"> 1. Check that the transducer connector pins on the back of the display are not bent or broken. 2. Check that the transducer cable connector is correctly orientated and fully inserted into the display connector and locked in position. 3. Check the condition of the transducer cabling and connectors for signs of damage or corrosion, and replace if necessary.
Vessel speed too high	Slow vessel speed and recheck.
Bottom too shallow or too deep	<p>The bottom depth may be outside of the transducers depth range, move vessel to shallower or deeper waters as relevant and recheck.</p> <p>Transducer minimum and maximum depths can be found in the technical specification for your transducer.</p>

Poor / problematic image

Possible causes	Possible solutions
Vessel stationary	Fish arches are not displayed if the vessel is stationary; fish will appear on the display as straight lines.
Cursor mode is active	The scrolling screen is paused in Cursor mode, press the Back button to resume scrolling.
Sensitivity settings may be inappropriate for present conditions.	Check and adjust sensitivity settings or perform a Sonar reset.
Damaged connectors/cabling	<ol style="list-style-type: none"> 1. Check that the transducer connector pins on the back of the display are not bent or broken. 2. Check that the transducer cable connector is correctly orientated and fully inserted into the display connector and locked in position. 3. Check the condition of the transducer cabling and connectors for signs of damage or corrosion, and replace if necessary.
Transducer location	<ul style="list-style-type: none"> • Check that the transducer has been installed in accordance with the instructions that were provided with the transducer. • If a transom mount transducer is mounted too high on the transom it may be lifting out of the water, check that the transducer face is fully submerged when planing and turning.
Transducer kicked-up	If the transducer has a kick-up mechanism, check that it has not kicked up due to hitting an object.
Transducer damaged or fouled	Check the condition of the transducer ensuring it is not damaged and is free from debris/fouling, clean or replace as necessary.
Turbulence around the transducer at higher speeds may affect transducer performance	Slow vessel speed and recheck.
Interference from another transducer	<ol style="list-style-type: none"> 1. Turn off the transducer causing the interference. 2. Reposition the transducers so they are farther apart.

10.5 Wi-Fi troubleshooting

Before troubleshooting problems with your Wi-Fi connection, ensure that you have followed the Wi-Fi location requirements guidance provided in the relevant installation instructions and performed a power cycle/reboot of the devices you are experiencing problems with.

Cannot find router network

Possible cause	Possible solutions
Router out of range or signal blocked.	<ul style="list-style-type: none"> Ensure router is broadcasting and in range of your display. If necessary, move router and display closer together and then turn the display's Wi-Fi off and back on again. If possible, remove any obstructions and then turn the display's Wi-Fi off and back on again.
Display Wi-Fi disabled.	Ensure Wi-Fi is enabled on the Display.
Router problem.	If possible, power cycle the router and then turn the display's Wi-Fi off and back on again.
Device not broadcasting.	<ol style="list-style-type: none"> If possible, enable broadcasting in the router's settings. You may still be able to connect to the router, when it is not broadcasting, by manually entering the router's network name and password in the Display's Wi-Fi settings page.
Router's Wi-Fi network is incompatible	The Display's Wi-Fi can only connect to 2.4 GHz networks.

Cannot connect to network

Possible cause	Possible solutions
Trying to connect to the wrong Wi-Fi network.	Ensure you are trying to connect to the correct Wi-Fi network; the Wi-Fi network's name can be found in the router's settings.
Incorrect network credentials.	Ensure you are using the correct password; the Wi-Fi network's password can be found in the router's settings.
Bulkheads, decks and other heavy structure can degrade and even block the Wi-Fi signal. Depending on the thickness and material used, it may not always be possible to pass a Wi-Fi signal through certain structures.	<ol style="list-style-type: none"> Try repositioning the display and if possible the router, so the structure is removed from the direct line of sight between the devices.
Interference being caused by other Wi-Fi enabled or older Bluetooth enabled devices (Bluetooth and Wi-Fi both operate in the 2.4 GHz frequency range, some older Bluetooth devices may interfere with Wi-Fi signals.)	<ol style="list-style-type: none"> If possible, change the Wi-Fi Channel that your router is using and retry the connection. You can use free Wi-Fi analyzer apps on a smart device to help you choose a better channel (channel with least traffic). Temporarily disable each wireless device in turn until you have identified the device causing the interference.

Possible cause	Possible solutions
<p>Interference caused by other devices that use the 2.4 GHz frequency. See following list of some common devices that use the 2.4 GHz frequency:</p> <ul style="list-style-type: none"> • Microwave ovens • Fluorescent lighting • Cordless phones / baby monitors • Motion sensors 	<p>Temporarily switch off each device in turn until you have identified the device causing the interference, then remove or reposition the offending device(s).</p>
<p>Interference caused by electrical and electronic devices and associated cabling could generate an electromagnetic field which may interfere with the Wi-Fi signal.</p>	<p>Temporarily switch off each item in turn until you have identified the device causing the interference, then remove or reposition the offending device(s).</p>

Connection extremely slow and / or keeps dropping out

Possible cause	Possible solutions
<p>Wi-Fi performance degrades over distance, so products farther away will receive less network bandwidth. Products installed close to their maximum Wi-Fi range will experience slow connection speeds, signal dropouts or not being able to connect at all.</p>	<p>Move display closer to router.</p>
<p>Interference being caused by other Wi-Fi enabled or older Bluetooth enabled devices (Bluetooth and Wi-Fi both operate in the 2.4 GHz frequency range, some older Bluetooth devices may interfere with Wi-Fi signals.)</p>	<ol style="list-style-type: none"> 1. If possible, change the Wi-Fi Channel that your router is using and retry the connection. You can use free Wi-Fi analyzer apps on a smart device to help you choose a better channel (channel with least traffic).. 2. Temporarily switch off each item in turn until you have identified the device causing the interference, then remove or reposition the offending device(s).
<p>Interference from devices on other vessels. When in close proximity to other vessels (for example, when moored up in a marina), many other Wi-Fi signals may be present.</p>	<ol style="list-style-type: none"> 1. If possible, change the Wi-Fi Channel that your router is using and retry the connection. You can use free Wi-Fi analyzer apps on a smart device to help you choose a better channel (channel with least traffic). 2. If possible, move your vessel to a location with less Wi-Fi traffic.

Network connection established but no data

Possible cause	Possible solutions
<p>No internet connection to router.</p>	<p>Ensure that your display is connected to a network with an internet connection.</p>

Chapter 11: Technical support

Chapter contents

- [11.1 Raymarine product support and servicing on page 126](#)
- [11.2 Learning resources on page 129](#)

11.1 Raymarine product support and servicing

Raymarine provides a comprehensive product support service, as well as warranty, service, and repairs. You can access these services through the Raymarine website, telephone, and e-mail.

Product information

If you need to request service or support, please have the following information to hand:

- Product name.
- Product identity.
- Serial number.
- Software application version.
- System diagrams.

You can obtain this product information using diagnostic pages of the connected MFD.

Servicing and warranty

Raymarine offers dedicated service departments for warranty, service, and repairs.

Don't forget to visit the Raymarine website to register your product for extended warranty benefits: <http://www.raymarine.co.uk/display/?id=788>.

Region	Contact
United Kingdom (UK), EMEA, and Asia Pacific	<ul style="list-style-type: none">• E-Mail: emea.service@raymarine.com• Tel: +44 (0)1329 246 932
United States (US)	<ul style="list-style-type: none">• E-Mail: rm-usrepair@flir.com• Tel: +1 (603) 324 7900

Web support

Please visit the “Support” area of the Raymarine website for:

- **Manuals and Documents** — <http://www.raymarine.com/manuals>
- **Technical support forum** — <http://forum.raymarine.com>
- **Software updates** — <http://www.raymarine.com/software>

Worldwide support

Region	Contact
United Kingdom (UK), EMEA, and Asia Pacific	<ul style="list-style-type: none">• E-Mail: support.uk@raymarine.com• Tel: +44 (0)1329 246 777
United States (US)	<ul style="list-style-type: none">• E-Mail: support@raymarine.com• Tel: +1 (603) 324 7900 (Toll-free: +800 539 5539)
Australia and New Zealand (Raymarine subsidiary)	<ul style="list-style-type: none">• E-Mail: aus.support@raymarine.com• Tel: +61 2 8977 0300
France (Raymarine subsidiary)	<ul style="list-style-type: none">• E-Mail: support.fr@raymarine.com• Tel: +33 (0)1 46 49 72 30
Germany (Raymarine subsidiary)	<ul style="list-style-type: none">• E-Mail: support.de@raymarine.com• Tel: +49 (0)40 237 808 0
Italy (Raymarine subsidiary)	<ul style="list-style-type: none">• E-Mail: support.it@raymarine.com• Tel: +39 02 9945 1001
Spain (Authorized Raymarine distributor)	<ul style="list-style-type: none">• E-Mail: sat@azimut.es• Tel: +34 96 2965 102
Netherlands (Raymarine subsidiary)	<ul style="list-style-type: none">• E-Mail: support.nl@raymarine.com• Tel: +31 (0)26 3614 905

Region	Contact
Sweden (Raymarine subsidiary)	<ul style="list-style-type: none"> E-Mail: support.se@raymarine.com Tel: +46 (0)317 633 670
Finland (Raymarine subsidiary)	<ul style="list-style-type: none"> E-Mail: support.fi@raymarine.com Tel: +358 (0)207 619 937
Norway (Raymarine subsidiary)	<ul style="list-style-type: none"> E-Mail: support.no@raymarine.com Tel: +47 692 64 600
Denmark (Raymarine subsidiary)	<ul style="list-style-type: none"> E-Mail: support.dk@raymarine.com Tel: +45 437 164 64
Russia (Authorized Raymarine distributor)	<ul style="list-style-type: none"> E-Mail: info@mikstmarine.ru Tel: +7 495 788 0508

Viewing hardware and software details (LightHouse™ Sport)

The **Getting started** tab in the homescreen **Settings** menu provides hardware and software information about your display.

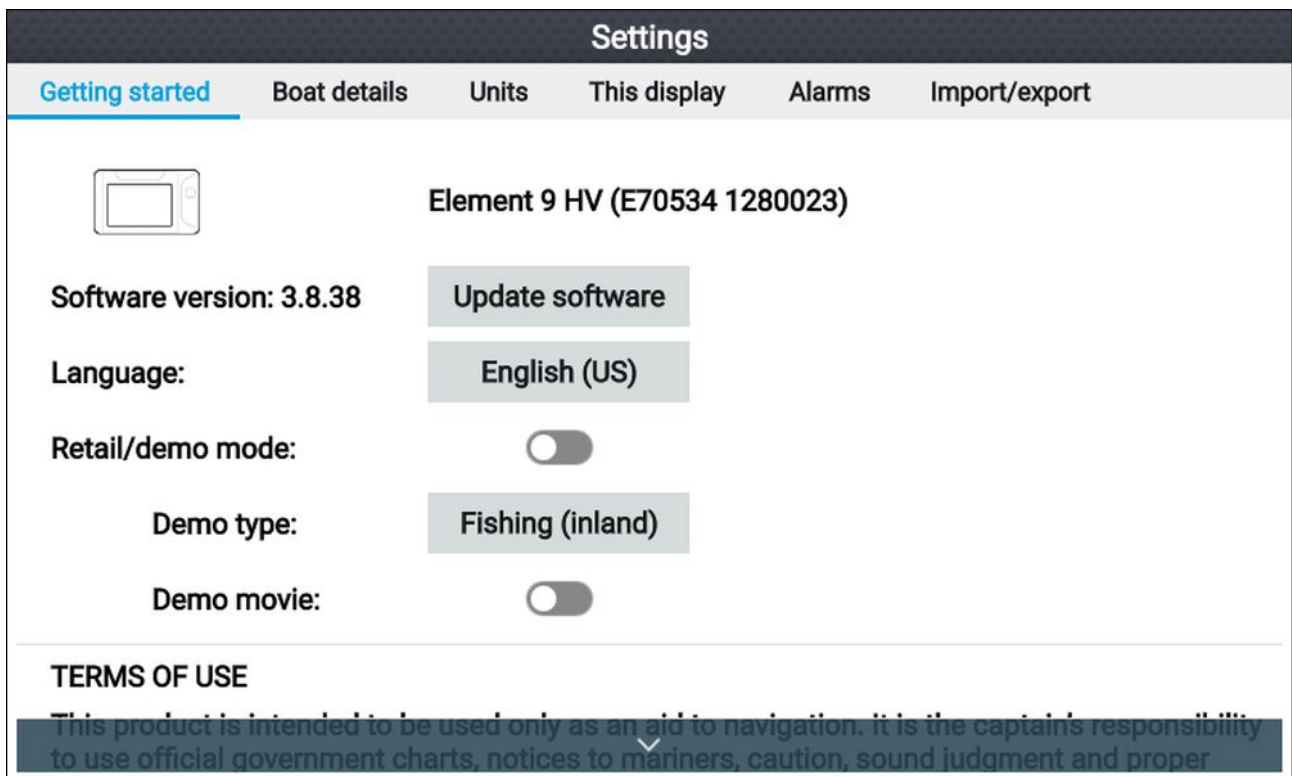

1. Select the **Settings** icon from the Homescreen.

Viewing product information

You can view detailed product information, for troubleshooting purposes, by following the steps below.

Product information	
Element 9 HV E70534 1280023	Save data
Application version:	3.8
CAN address:	00
CMAP base map version:	1.0-00006
CMAP library version:	CI-2.0.0R SDK-15.0.0R (04/09/2017)
CPU revision:	Unknown
Crash logs:	0
Hardware revision:	6
Kernel version:	3.18.31-perf (Wed Jan 23 03:46:05 GMT 2019)
Navionics base map version:	1.0-00006
Navionics library version:	NI_01.03.40.19_UV_2337_CI_03.05
Platform version:	0.00.100
Power micro version:	100
Product bundle version:	3.8.46
Product family:	Element
Product ID:	E70534
Product name:	Element 9 HV
Rx5 base map version:	1.0-00006
Sonar Platform version:	P7.1 A3.8

1. Select the **Settings** icon from the **Homescreen**.
2. Select the **This display** tab.
3. Select **Prod info** from the **TROUBLESHOOTING** section.
4. If required, use the **Up** button and **Down** button to scroll through the available information.

Saving diagnostics data

The information displayed on the Product information page can be saved to memory card.



With the Product info page displayed:

1. Use the **Right** button to select **Save data**.
2. Enter a filename for the data using the onscreen keyboard, or keep the default filename.
3. Select **Save**.
4. Select **Eject card** to safely remove the memory card, or select **OK** to return to the **Product information** page.

11.2 Learning resources

Raymarine has produced a range of learning resources to help you get the most out of your products.

Video tutorials

	<p>Raymarine official channel on YouTube:</p> <ul style="list-style-type: none">• YouTube <p>LightHouse™ 3 tips and tricks:</p> <ul style="list-style-type: none">• Raymarine website
	<p>Video Gallery:</p> <ul style="list-style-type: none">• Raymarine website

Note:

- Viewing the videos requires a device with an Internet connection.
- Some videos are only available in English.

Training courses

Raymarine regularly runs a range of in-depth training courses to help you make the most of your products. Visit the Training section of the Raymarine website for more information:

- <http://www.raymarine.co.uk/view/?id=2372>

Technical support forum

You can use the Technical support forum to ask a technical question about a Raymarine product or to find out how other customers are using their Raymarine equipment. The resource is regularly updated with contributions from Raymarine customers and staff:

- <http://forum.raymarine.com>

Appendix A NMEA 2000 PGNs

PGN	Description	Transmit	Receive
59904	ISO Request	•	•
60160	ISO Transport Protocol, Data Transfer		•
60416	ISO Transport Protocol, Connection Management — BAM group function	•	•
60928	ISO Address Claim	•	•
65240	ISO Commanded Address		•
126208	NMEA - Acknowledge Group Function	•	
126208	NMEA - Command Group Function		•
126208	NMEA - Request Group Function		•
126464	PGN Lists	•	•
126993	Heartbeat	•	•
126996	Product Information	•	•
126998	Configuration Information	•	

Raymarine® provides field programmability of the Device and System Instances within PGN 60928 which can be commanded via use of PGN 126208 as required by the latest **NMEA 2000** standard.

Index

A

Alarms	49
Acknowledgement.....	49
Dangerous	49
Warning	49
Align to GPS	37
App pages	
Customize.....	43
Delete	43
New	44
Quicklaunch.....	43
Rename.....	43
Applications.....	41
Apps	41
Chart	41
Dashboard	41
Fishfinder.....	41

B

Back	
Button	24
Back up	
User data	36
Backup	
Routes.....	36
Tracks	36
Waypoints	36
Battery	
Data items.....	18, 110
Battery selection.....	52, 112
Black water tank selection.....	52, 112
Boat	
Data items.....	18, 110
Boat details.....	52, 112
Boat position	74
Brightness	29

C

Cartography.....	86
Selection.....	72
Chart.....	87–88
2D shading	89
Aerial coverage.....	87
Aerial layer.....	87
Auto range motion.....	73
Boat icon.....	86
Boat position.....	73, 86
Center position	73
Context menu	71
Contours	87
Course-up.....	73
Current graph	77
Current graphic.....	76
Current station	76
Detailed mode	72
Find nearest.....	82
Fishing mode	73
Full offset	73
Goto.....	79

Head-up.....	73
Icon type	86
Motion mode.....	73, 86
Nav marks.....	87
North-up.....	73
Object cursor	74
Orientation.....	73, 86
Partial offset.....	73
RealBathy.....	84
Record depth data	88
Relative motion	73
Running mode	73, 87
Search for objects.....	82
Set up	86
Shallow area	87
Simple mode.....	72
Tide animation interval	86
Tide bar.....	75
Tide graph	76
Tide station	75
Tides.....	87
True motion	73
Chart app	
Context menu	71
Cursor mode.....	71
Motion mode.....	71
Overview.....	70
Panning.....	71
Placing waypoint.....	71
Range	71
Chart detail.....	86
Chart range	70
Chart,	
Modes.....	72
COG line.....	70, 74
COG reference period.....	74
Color theme.....	29–30
Community edits.....	87
Compass offset.....	37
Confirming selection	24
Contact details.....	126
Creation.....	66, 81
Cross track error.....	80
Cursor mode	
Activating.....	24
Positioning	24

D

Dashboard	
Engine RPM limits	113
Pages	109
Pages tab.....	111
Show / Hide pages	109
Data items	
Battery	18, 110
Boat	18, 110
Depth.....	18, 110
Display	18, 110
Distance.....	18, 110
Engines.....	19, 110
Environment.....	19, 111
Fuel.....	19, 111
GPS / GNSS	19, 111

Heading	19, 111
Navigation.....	19, 111
Time.....	19, 111
Data source	
GNSS (GPS).....	46
Position data	46
VHF.....	46
Databoxes	17, 70
Edit.....	17
Hide	18
Show.....	18
Deep contour	87
Deep water color.....	88
Depth	
Data items.....	18, 110
Depth offset.....	27, 99
Destination line.....	70
Destination waypoint.....	70
Diagnostics.....	127
Directional pad	24
Display	
Buttons.....	24
Controls	24
Data items.....	18, 110
Distance	
Data items.....	18, 110
Document conventions	16
Documentation.....	12

E

Eject SD card.....	29
Engine connection wizard	52, 112
Engine identification wizard	27
Engine selection.....	52, 112
Engines	
Data items.....	19, 110
Environment	
Data items.....	19, 111
Export	
Routes.....	36
Tracks	36
User data	36
Waypoints	36

F

Factory reset	117
Fishfinder	
2nd echo rejection.....	104
A-scope.....	102
All to Auto	98
Color palette	101–102
Color threshold	101–103
Current temperature	102–103
Databoxes.....	105
Depth lines.....	101–102
Fish depth labels.....	104
Fish detection	104
Fish detection sensitivity.....	104
Fish icons.....	104
Gain	98
Intensity	98
Interference rejection	104

Manual temperature range	101, 103
Maximum temperature.....	102–103
Minimum temperature.....	102–103
No transducer	94
Range lines	101
Scroll back	97
Scroll speed.....	101–103
Sensitivity controls.....	98
Settings menu.....	100
Sonar channels	95
Sonar display menu	100–102
Sounder menu	104
Sounder reset.....	104
Surface filter.....	98
Temperature graph.....	101–102
Transducer	103
Transducer alignment.....	103
Transducer menu.....	103
Transducer offset.....	103
Transducer ping.....	104
Transducer ping rate	104
Transducer temperature	103
Transducer temperature calibration	103
Transducer temperature sensor	103
Waypoint.....	96
Fishing zone	89
Follow.....	80
Fresh water tank selection	52, 112
Fuel	
Data items.....	19, 111
Fuel tank selection	52, 112

G

Goto waypoint	79
GPS / GNSS	
Data items.....	19, 111
GPS/GNSS	
COG/SOG filter	46
Fix	45
Satellite status.....	45
Settings.....	46
Gray water tank selection.....	52, 112

H

Heading	
Data items.....	19, 111
High res bathy	87
Home	
Button	24
Homescreen.....	40
Navigation.....	24
Show.....	24

I

Import	
Routes.....	28, 36
Tracks	28, 36
User data	36
Waypoints	28, 36

L

Languages.....	51
Selection.....	51
LightHouse™ 3	
Tips and Tricks.....	129
LightHouse Sport	
Compatible Displays.....	12
Limitations on Use.....	41
Limitations on Use (LoU).....	41
Live well tank selection.....	52, 112

M

Memory cards	
Compatibility.....	31
Menu	
Button.....	24
Closing.....	24
Opening.....	24
Menus	
Settings.....	16
Types.....	20
MicroSD	
Adaptor.....	31
inserting into display.....	32
Removal.....	32
Minus	
Button.....	24

N

N2K PGNs.....	131
Navigation	
Data items.....	19, 111
Notifications.....	49

O

OK	
Button.....	24

P

PGN support.....	131
Plus	
Button.....	24
Power	
Button.....	25
Power consumption.....	25
Power off.....	25, 29
Power on.....	25
Power troubleshooting.....	117
Product information.....	127
Product support.....	126

Q

Quicklaunch	
Button assignment.....	25
Buttons.....	24
Quicklaunch buttons.....	41

R

Range in.....	24
Range out.....	24
RealBathy.....	84, 88
Chart.....	84
Density.....	85
Height correction.....	84
RealBathy.....	84
Visibility.....	85
Waterline to tdcr.....	84
Recovery mode.....	117
Restore	
Routes.....	28, 36
Tracks.....	28, 36
Waypoints.....	28, 36
Route.....	62, 70
Add waypoint.....	65
Building.....	62
Capacity.....	62
Creation.....	62
Export.....	62
Follow.....	65, 80
Follow from here.....	80
Import.....	62
List.....	64, 67
Management.....	64
Menu.....	64, 67
Plan.....	64
Remove waypoint.....	65
Reverse.....	65
Route options.....	65

S

Safe depth, minimum.....	52, 112
Safe height, minimum.....	52, 112
Safe width, minimum.....	52, 112
Screenshot.....	29
Service Center.....	126
Shortcuts	
Menu.....	29
Shortcuts menu	
Opening.....	25
Software	
Compatible Displays.....	12
Software updates.....	33–35
Software version.....	12
Sonar	
History.....	97
Ping.....	29
Sonar channels.....	95
Sonar logs.....	88
Sonar ping	
Enable/Disable.....	30
SonarChart Live.....	88, 90
Enabling.....	90
Tide correction.....	90
Sports fishing.....	87
Startup wizard.....	26
Status area.....	47
Support forum.....	129
Switching active app.....	24–25

T

Take Screenshot	29
Technical support.....	126, 129
Time.....	47
Data items.....	19, 111
Time/Date format.....	52, 112
Timer	47
Count down	47
Count up	48
Track.....	66, 70, 81
Create route.....	66
Export	66
Import.....	66
Start	66, 74, 81
Stop	74
Tracks	66
Capacity.....	66
Color	68
Create route.....	67
Deletion	67
Edit.....	67
Hide	67
Interval	68
List	67
Management.....	67
Menu.....	67
Options	67
Record by	68
Show.....	67
Training courses.....	129
Transducer	
Configuration	27, 99
port/starboard swap	27, 99
Setup	27, 99
Temperature calibration	27, 99
Temperature settings.....	27, 99
Transducer alignment.....	27, 99
Transducer offset	88
Troubleshooting	116
GNSS (GPS).....	119
Wi-Fi.....	122

U

Units	52, 112
Upgrading, software	33
User data	
Restore	
Back up	36
User interface	
Languages	51

V

Vessel details	74
Vessel icon	70
Vessel symbol	74
Video Gallery.....	129

W

Warranty	126
Waypoint	56, 70

Arrival alarm.....	79
Arrival circle	79
Button	24
capacity.....	56
Comments	57
Creation	60
Customizing	57
Delete	57
Details.....	57, 60
Export	56
Find.....	61
Goto	57, 79
Group.....	57
groups.....	58, 61
Import.....	56
List	59
Menu.....	58, 61
Name	57, 60
Notes	57
Placement.....	24, 56–57, 71, 96
Waypoint group	
Creation	60
Deletion	60
Hide	61
Show.....	61

X

XTE,	
Restart.....	80

Z

Zoom in	24
Zoom mode	
Activating.....	24
Zoom out	24



Raymarine

Marine House, Cartwright Drive, Fareham, Hampshire.
PO15 5RJ. United Kingdom.

Tel: +44 (0)1329 246 700

www.raymarine.com

Raymarine®

a brand by  **FLIR®**