

LOWRANCE

SIMRAD

TotalScan

Transducer

Installation manual

ENGLISH

1

Preface

⚠ Warning: It is your sole responsibility to install and use the instrument and transducer(s) in a manner that will not cause accidents, personal injury or property damage. Always observe safe boating practices.

Sonar performance: The accuracy of the sonar depth display can be affected by many factors, including the type and location of the transducer and water conditions. Never use this instrument to gauge depth or other conditions for swimming or diving.

The choice, location, and installation of transducers and other components of the system are critical to the performance of the system as intended. If in doubt, consult your Navico dealer.

To reduce the risk of misusing or misinterpreting this instrument, you must read and understand all aspects of the Installation and Operation manuals. We also recommend that you practice all operations using the built-in simulator before using this instrument on the water.

Disclaimer: Navico Holding AS and its subsidiaries, branches and affiliates disclaim all liability for any use of this product in a way that may cause accidents, damage or that may violate the law.

Compliance Statements: The TotalScan Transducer complies with:

- CE under EMC directive 2014/30/EU
- The requirements of level 2 devices of the Radiocommunications (Electromagnetic Compatibility) standard 2008

The relevant Declaration of Conformity is available at the following websites under the TotalScan Transducer documentation section:

- <http://www.lowrance.com/>
- <http://www.simrad-yachting.com/>

Trademarks: Lowrance[®] and Navico[®] are registered trademarks of Navico. Simrad[®] is used by license from Kongsberg.

This manual refers to the following Navico products: DownScan Imaging™ (DownScan), DownScan Overlay™ (DownScan Overlay), StructureScan[®] (StructureScan), and StructureScan[®] HD (StructureScan HD).

Copyright: Copyright © 2016 Navico Holding AS.





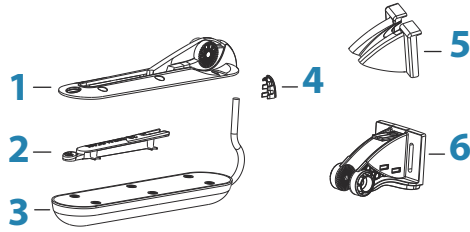

2



Check the contents

Included with the TotalScan Transducer, is the transom mounting bracket assembly parts, and a hardware mounting kit. The transducer has a 7 m (24 ft) cable attached.



- 1 Bracket
- 2 Insert/name plate
- 3 Transducer
- 4 Plug
- 5 Cable cover
- 6 Transom mounting plate

Hardware mounting kit (included)	
	Transom mount screws #10x1-1/4" (3)
	#10 flat washers for transom mount screws (3)
	Bracket assembly bolt M6x40mm (1)
	Bracket assembly washer M6 (1)
	Bracket assembly rubber spring washer M6 (1)
	Bracket assembly nylon lock nut M6 (1)

Hardware mounting kit (included)	
	Transducer attachment screws M4x8mm (6)
	Transducer attachment lock washers M4 (6)
	Zip ties (2)

Required tools and supplies (not included)	
Drill	Phillips (cross-head) screwdriver
Drill bits	Marine high-grade above- or below-waterline sealant/adhesive compound

3

Installation

Mounting options

The transducer can be mounted on the transom, jackplate, or step. Use the following table to determine which mounting option is best suited to your boat/installation preferences.

- **Note:** Before drilling any holes, ensure that holes are drilled in a safe position. Ensure you do not drill into tanks, reservoirs, hoses, or cables, etc. and that the holes will not weaken the structure in any way.
- **Note:** When mounting the transducer, make sure there is nothing around the mounting location that could interfere with its sonar beams.
- **Note:** If mounting where the transducer comes out of the water, for example when the boat is on plane, the sonar will not work while the transducer is out of the water.

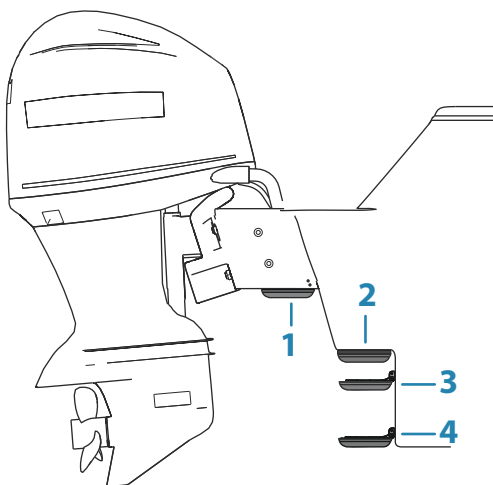

- 1 Jackplate mount (Transom bracket)
Requires separately sold Skimmer Transom mount kit (part no. 000-12603-001)

- 2 Direct Step mount (Flush bracket)
Requires separately sold Skimmer Flush mount kit (part no. 000-12602-001)
- 3 Step mount (Transom bracket)
- 4 Transom mount (Transom bracket)

TotalScan Transducer mounting options	
<p>Transom mount (Transom bracket) Refer to <i>"Transom and step mount (Transom bracket)"</i> on page 8</p>	<ul style="list-style-type: none"> Keeps transducer in the water when the boat is on plane, allowing you to track bottom at high speeds Transducer angle can be adjusted so it is parallel with the water Transducer more likely to collide with obstructions in the water and adds drag to the boat
<p>Step mount (Transom bracket) Refer to <i>"Transom and step mount (Transom bracket)"</i> on page 8</p>	<ul style="list-style-type: none"> Transducer is not in the water when boat is on plane; protects transducer and prevents drag from transducer Transducer angle can be adjusted so it is parallel with the water Sonar does not track bottom when transducer comes out of the water
<p><i>"Jackplate mount (Transom bracket)"</i> on page 12 Requires separately sold Skimmer Transom mount kit (part no. 000-12603-001)</p>	<ul style="list-style-type: none"> Transducer is not in the water when boat is on plane; protects transducer and prevents drag from transducer Transducer angle can be adjusted so it is parallel with the water Allows you to mount transducer without drilling holes in your boat Sonar does not track bottom when transducer comes out of the water

TotalScan Transducer mounting options

"Direct Step mount (Flush bracket)" on page 10
Requires separately sold Skimmer Flush mount kit (part no. 000-12602-001)

- Transducer is not in the water when boat is on plane; protects transducer and prevents drag from transducer
- Transducer angle cannot be adjusted so it is parallel with the water
- Sonar does not track bottom when transducer comes out of the water

Transducer angle

After mounting the transducer, make sure the transducer is adjusted so it will be parallel with the waterline in both the horizontal and vertical axis when moving at trolling speed.

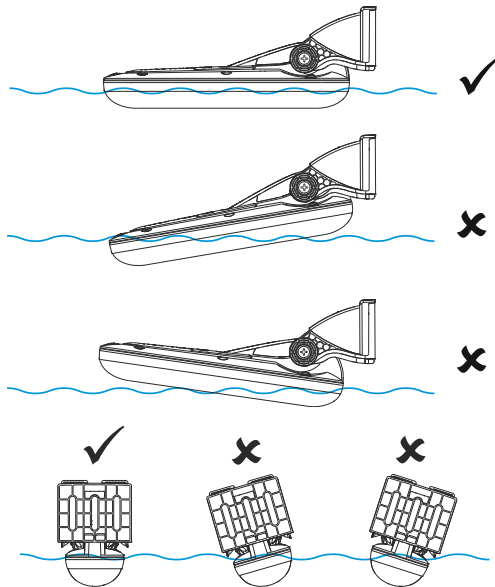

Transom and step mount (Transom bracket)

The transducer can be mounted to the transom or step with the transom bracket. With these mounting options the transducer can

be in the water when you are on plane, or can be mounted so it is only in the water when you are moving at trolling speed.

Transom and Step mount (fiberglass) supplies (not included)	
3 mm (1/8") Drill bit (Transom mount pilot holes)	Marine high-grade above- or below-waterline sealant/ adhesive compound

Transom mount (aluminum hull) supplies (not included)	
M4 Machine Screws	Marine high-grade above- or below-waterline sealant/ adhesive compound
Plastic isolating material such as King Starboard (prevents corrosion between bracket and aluminum hull)	

To mount on transom or step using the transom bracket

1. Snap the plug to the bracket (A)
2. Attach the bracket and name tag insert to the transducer using the supplied screws (B)
3. Loosely attach the bracket with the transducer to the transom mounting plate using the supplied bracket assembly bolt, washer (closest to the screw head), rubber spring washer and nylon lock nut (C)
4. Hold the whole assembly up against the transom or transom step to the desired position. If mounting on the transom, align the bottom of the transducer with the bottom of boat. Use a pencil to mark the pilot holes (D). The transom mounting plate has screw slots for adjusting the transducer position height.
5. Drill the pilot holes
6. Apply a marine high-grade above- or below-waterline sealant/ adhesive compound to the pilot holes
7. Disconnect the transom mounting plate from the transducer bracket
8. Screw the transom mounting plate to the transom using the supplied screws and flat washers (E)

9. Run the transducer cable up through the grommet on the mounting bracket (F)
10. Reattach the transducer bracket to the transom mounting plate (G)
11. Set the transducer to the desired angle and tighten the bracket assembly bolt (with washers) and nylon lock nut
12. Snap the cable cover into place (H). If needed, you can remove the cable cover by inserting a flat head screw driver along the curved edge and pry the clip loose on both sides, one side at a time.
13. Route the cable to the display and connect it to the sonar port.

After the transducer is connected and your boat is in the water, turn on the Flip Left/Right feature on your display to ensure what is shown on the left and right side on your display corresponds with what is on the left and right side of your boat. Refer to your display's Operation manual for more information.

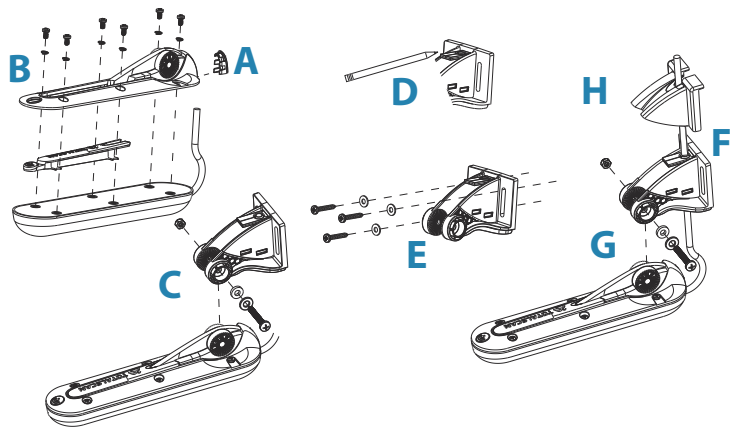

Direct Step mount (Flush bracket)

Flush mount bracket assembly

To mount the transducer directly to the step (Direct Step mount), use the flush mount bracket (sold separately, part no. 000-12602-001).

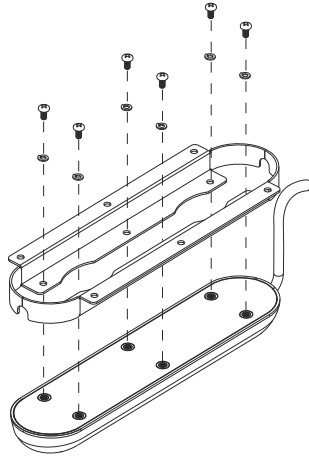

Direct Step mount (Flush bracket) installation

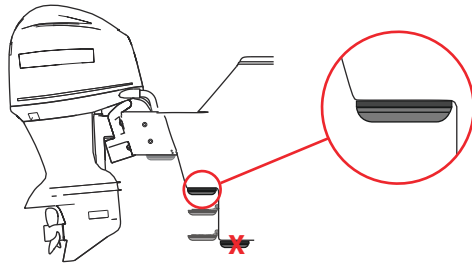

→ **Note:** Do not install the transducer under the hull.

You can mount the transducer in either direction; with the cable coming out towards or away from the transom when installing with the direct step (Flush bracket) mount.

→ **Note:** Sonar does not track bottom when the transducer is out of the water.

Direct step mount bracket and supplies (not included)

Pilot hole drill bit (Direct Step mount pilot holes for self-tapping metal screws)

Marine high-grade above- or below-waterline sealant/ adhesive compound

Direct step mount bracket and supplies (not included)

Maximum 5 mm (#10 or 3/16")
self-tapping metal screws

To direct step mount using flush bracket

1. Make sure the boat's step is the same length or longer than the transducer.
2. After selecting a mounting location, route the transducer cable to the location where the display will be installed.
3. Attach the transducer to the surface bracket and hold in the desired position. Use a pencil to mark pilot holes through the mounting holes on the surface bracket.
4. Drill the pilot holes.
5. Apply a marine high-grade above- or below-waterline sealant/adhesive compound to the pilot holes.
6. Align the transducer mounting holes over the pilot holes and mount the transducer to the step using self-tapping metal screws (not supplied). Do NOT overtighten the screws; otherwise you could strip out the fiberglass pilot holes or crack the mounting holes on the transducer.
7. Connect the transducer cable to the display sonar port.

After the transducer is connected and your boat is in the water, turn on the Flip Left/Right feature in your display unit to ensure what is shown on the left and right side on your display corresponds with what is on the left and right side of your boat. Refer to your display unit's Operation manual for more information.

Jackplate mount (Transom bracket)

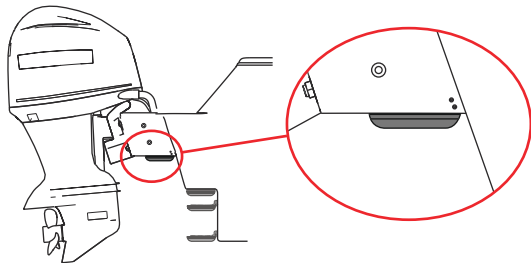

→ **Note:** Jackplate mount requires the separately sold 'StructureScan 3D, StructureScan HD & TotalScan Skimmer Transom mount kit' (part no. 000-12603-001).

The transducer transom bracket can be mounted inside or outside of the jackplate by drilling through the jackplate and then running bolts through the hinge hole in the side of the bracket into the jackplate. The illustration above shows the transom bracket mounted inside the jackplate.

→ **Note:** Sonar does not track bottom when the transducer is out of the water.

Jackplate mount supplies (not included)	
6 mm (1/4") Drill bit (Jackplate Mount)	M6 (1/4") jackplate mount bolts

⚠ Warning: Before installing the transducer on the jackplate, lower the jackplate to its lowest setting to make sure there is enough clearance between the jackplate, engine, transom, and the transducer. Lack of clearance could damage the transducer when the engine is all the way down.

To mount transducer on jackplate using transom bracket

1. Choose a transducer location on the inside or outside of the jackplate.
2. Adjust the jackplate up and down to make sure the transducer will not obstruct jackplate movement.
3. Make sure nothing blocks the sonar beam on either side of the transducer.
4. Route the transducer cable to the location where the display will be installed.
5. Move the transducer bracket into the desired position and use a pencil to mark the holes through the hinge hole and hole in the side of the bracket.
6. Using a 6mm or equivalent drill bit, drill the holes into the jackplate.
7. Slide the bracket inside the jackplate and align the bracket holes with holes you drilled in the jackplate.

8. Slide M6 bolts with washers into each hole on the side of jackplate.
9. Guide the bolts through the Transducer mounting bracket holes.
10. Place a washer over the end of the bolts and tighten the nuts.
11. Connect the transducer cable to the display sonar port.

After the transducer is connected and your boat is in the water, turn on the Flip Left/Right feature in your display unit to ensure what is shown on the left and right side on your display corresponds with what is on the left and right side of your boat. Refer to your display unit's Operation manual for more information.

4

Dimensions

Transducer and transom mount bracket

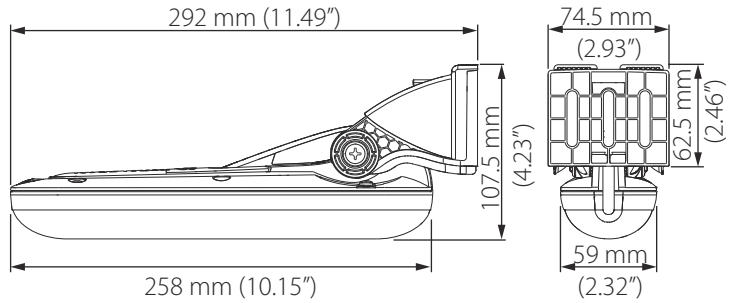

Transducer cable

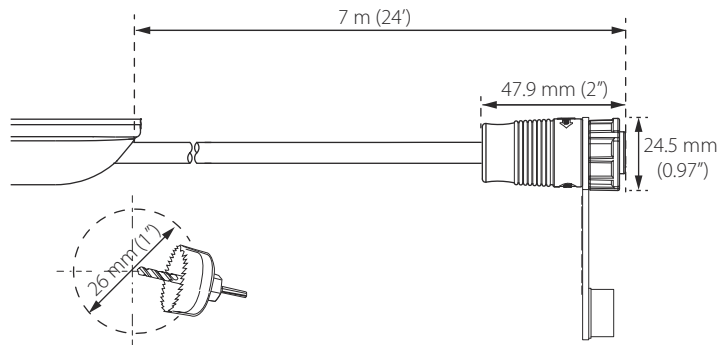

A 26mm (1") diameter hole is recommended for cable clearance.

5

Parts and accessories

The most up-to-date parts and accessories are available at:
www.simrad-yachting.com or www.lowrance.com.

TotalScan Transducer (000-12568-001)

Includes transducer, transom mounting bracket, and assembly and mounting screws, washers, and nuts.

TotalScan (plastic) Skimmer Transom mount kit (000-22068-00)

Includes transom mounting bracket, and bracket assembly and mounting screws, washers, and nuts. For mounting transducer on transom/step.

StructureScan 3D, StructureScan HD & TotalScan Skimmer Transom mount kit (000-12603-001)

Includes transom mounting bracket, and bracket assembly and mounting screws, washers, and nuts. For mounting transducer on jackplate.

StructureScan 3D & TotalScan Skimmer Flush mount kit (000-12602-001)

Includes 2 piece Flush mount mounting bracket. Use assembly and mounting hardware supplied with the transducer.

10-FT 9-Pin Transducer Extension cable (000-0099-006)

6

Specifications

Sidescan specifications

Max Range	455 kHz - 182 m (600 ft) total, 92 m (300 ft) on each side 800 kHz - 60 m (200 ft) total, 30 m (100 ft) on each side
Max Speed	56 kph (35 mph)
Mark objects	24 kph (15 mph)
Optimum speed	16 kph (10 mph) or less

Downscan specifications

Max Depth	92 m (300 ft)
Max Speed	88 kph (55 mph)
Mark objects	56 kph (35 mph)
Optimum speed	16 kph (10 mph) or less

CHIRP sonar specifications

Max Depth	High CHIRP - 200 kHz 305 m (1000 ft) Medium CHIRP - 83 kHz 305 m (1000 ft)
Max Speed	88 kph (55 mph)

7

Troubleshooting tips

Troubleshooting tips	
Sonar data is not displayed	<ul style="list-style-type: none">• Check transducer cable is connected to display unit• Check sonar is enabled in display unit, refer to display unit Operator manual• Check transducer is submerged in the water
No depth	Check range or turn on auto range
Data washed out / same color	Turn down contrast; try different palettes
Left/right data swapped on screen	Toggle the Flip Left/Right feature
No source is displayed	<ul style="list-style-type: none">• Ensure the sonar is enabled in display unit, refer to display unit Operator manual• Check transducer cable is connected to display unit



LOWRANCE

SIMRAD

www.lowrance.com
www.simrad-yachting.com