

CRW 400 - Product Manual

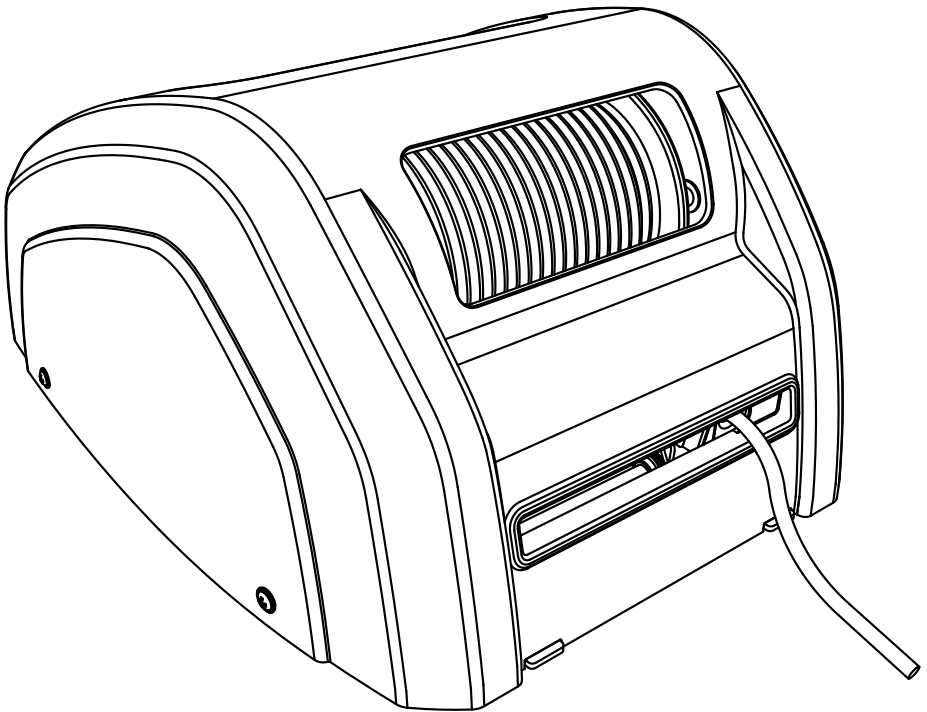

1- Introduction

Thank you for choosing Lewmar. Lewmar products are world renowned for their quality, technical innovation and proven performance. With a Lewmar product you will be provided with many years of outstanding service.

Product Support

Lewmar products are supported by a worldwide network of distributors and Authorised Service Representatives. If you encounter any difficulties with this product, please contact your national distributor, or your local Lewmar dealer. Details are available at: www.lewmar.com

CE Approvals

For CE approval certificates contact Lewmar.

Important information about this manual

Throughout this manual, you will see safety and product damage warnings. You must follow these warnings carefully to avoid possible injury or damage.

2- Specifications

35m (115ft) of 6mm (1/4") rope

 WARNING!

Only genuine Lewmar-supplied replacement rope kit should be used. This is critical to the correct function of the unit. The auto-stop and level-wind features will not work if you do not use the genuine Lewmar rope kit and serious damage to the unit could result.

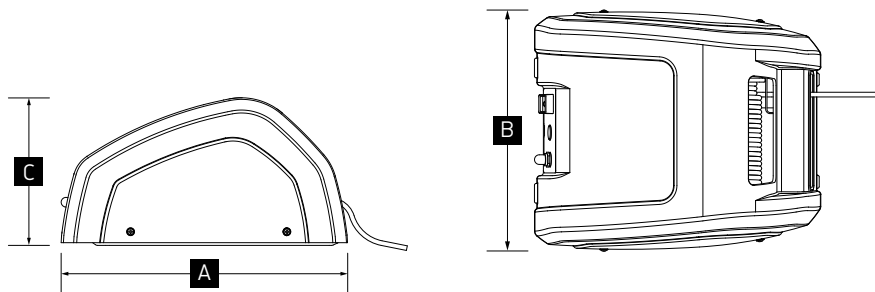

A		B		C	
mm	in	mm	in	mm	in
365	14 3/8	303	11 15/16	188	7 2/5

MODEL	MOTOR SUPPLY	MOTOR POWER	MAXIMUM LINE SPEED		MAX ANCHOR WEIGHT		NORMAL CURRENT DRAW	WEIGHT	
	Voltage	Watt	m/min.	ft/min.	kg	lb	Amp	kg	lb
CRW400	12	400	25	82	16	40	15	8.5	19

3- Safety Notice

**WARNING!****IMPORTANT: Read these notes before continuing.**

3.1 Windlass general

At all times it is the responsibility of the boat operator to ensure that the anchor and rode are properly stowed for the prevailing sea conditions. This is particularly important with high-speed powerboats, because an anchor accidentally deploying while under way can cause considerable damage. An anchor windlass is mounted in the most exposed position on a vessel and is thus subject to severe atmospheric attack resulting in a possibility of corrosion in excess of that experienced with most other items of deck equipment. As the windlass may only be used infrequently, the risk of corrosion is further increased. It is essential that the windlass is regularly examined, operated and given any necessary maintenance.

Please ensure that you thoroughly understand the operation and safety requirements of the windlass before commencing the installation. Only persons who are completely familiar with the controls and those who have been fully made aware of the correct use of the windlass should be allowed to use it. If there is any doubt of how to install or operate this unit please seek advice from a suitably qualified engineer.

- Windlasses used incorrectly could cause harm to equipment or crew.
- Windlasses should be used with care and treated with respect.
- Boating, like many other activities can be hazardous. Even the correct selection, maintenance and use of proper equipment cannot eliminate the potential for danger, serious injury or death.
- Lewmar windlasses are designed and supplied for anchor control in marine applications and are not to be used in conjunction with any other use.
- Keep limbs, fingers, clothing and hair clear of windlass, rode and anchor during operation. Severe bodily harm could result.
- Ensure there are no swimmers or divers nearby when dropping anchor.
- Windlasses must not be used as the sole means of securing the anchor to the bow fitting especially under storm conditions. Anchors should be independently secured to prevent accidental release.
- Classification Societies require that a vessel lying at anchor must have its anchor rope/chain secured to a chain stopper or other suitable independent strong point.
- A windlass should never be used as a mooring bollard, the anchor rode **MUST** be secured to a mooring cleat, chain stopper or other designated strong point. Using the windlass to secure the rode will damage the windlass.
- Do not use windlass for ANY purpose other than deployment and recovery of anchor.
- The circuit breaker in this product must never be deactivated or otherwise bypassed, it is intended to protect the motor and cables from overheating and damage.
- Always switch off this windlass at the circuit breaker/isolator when not in use.
- It is the unavoidable responsibility of the owner, master or other responsible party to assess the risk of any operation on the vessel.
- Windlass must not be operated whilst under the influence of alcohol or drugs.

3.2 Fitting

- This equipment must be installed and operated in accordance with the instructions contained in this manual. Failure to do so could result in poor product performance, personal injury and/or damage to your boat.
- Consult the boat manufacturer if you have any doubt about the strength or suitability of the mounting location.

3.3 Electrical

- Make sure that the boat's battery power supply has been switched off before starting the installation.
- This product requires installation by a suitably qualified electrical engineer.

4- Installation

4.1 Basic requirements

Each installation requires the following tools:

WINDLASS INSTALLATION

- Electric drill
- 8.5mm ($\frac{21}{64}$ ") drill bit
- 12mm ($\frac{1}{2}$ ") drill bit
- Sealant
- 4 M8 ($\frac{5}{16}$ ") bolts of suitable length, washers, nuts

WIRING INSTALLATION

- Crimping Pliers / Wire Stripper
- Suitable electrical cable and crimp terminals

4.2 Accessories

Use only genuine Lewmar parts and accessories to ensure top performance and eliminate the risk of voiding your warranty. For replacement parts, please visit your dealer or www.lewmar.com

4.3 Above deck preparation

IMPORTANT - Plan location carefully and allow for the following:

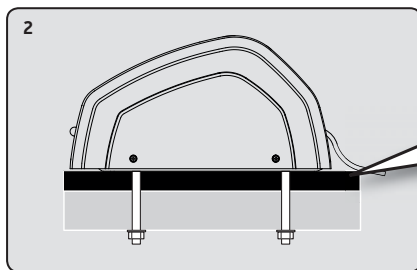
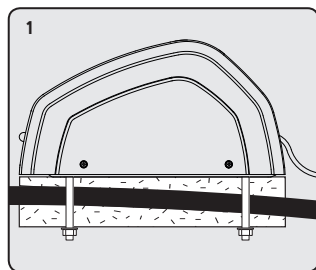

25mm (1") minimum deck thickness

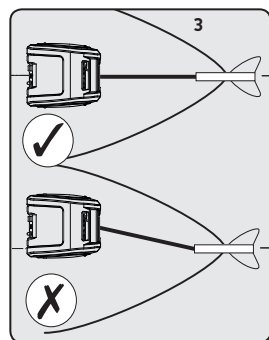

1. If the deck is not flat, a suitable mounting pad may be required to take up camber or sheer.

NOTE: If in doubt about the suitable construction of the pad consult a qualified marine engineer. The deck is an integral component of the windlass it has to secure the windlass and be strong enough to cope with the high torque stresses involved in recovering the anchor. Decks that are thin, or of foam or balsa laminate construction, will require reinforcement in order to spread the loads that will be applied to the deck while the windlass is in use.

2. Lewmar recommends a minimum deck thickness of 25mm (1")

3. The windlass should be placed such that the centre-line of the anchor shank or bow-roller is coincidental to the centre-line of the windlass housing.

4.4 Below deck preparation

IMPORTANT: The positioning of the windlass must be checked prior to cutting for deck/hull and bulkhead clearance for the mounting bolts and wiring (if led below deck).

Lead from the roller should be fed horizontally back to the CRW rope feeder.

4.5 Above deck fitting

Remove the lid from the unit by removing the 4 screws (2 on each side of the unit) and lifting up and out of the locating tabs.

CAUTION - Be aware of wires connected to the controls on the lid. There is enough slack to tilt back the lid and rotate it around so that it is out of the way during installation.

Lay the chassis in place and mark the location of the 4 mounting holes onto the deck.

If you wish to lead the motor wires below deck, mark a further 12mm (1/2") hole in the location shown below. Alternatively, for above deck installations, lead the wires through the existing chassis hole and secure with a cable tie as shown below.

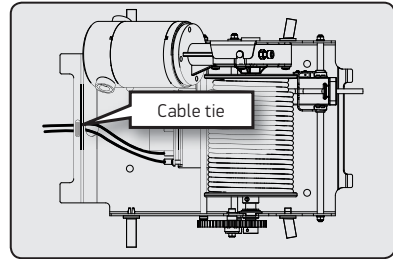
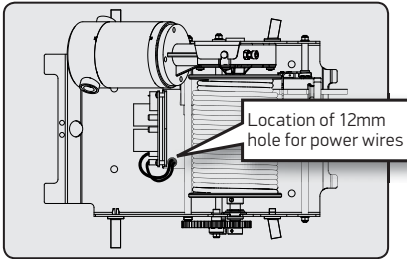

Place the unit to one side and using an 8.5mm (1/32") diameter drill bit, make four holes for the mounting bolts and, if required, use a 12mm (1/2") drill bit to make the hole for the power wires (optional).

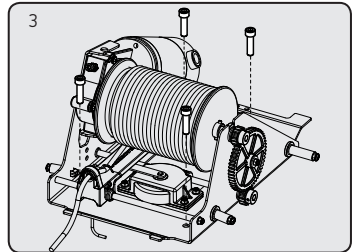
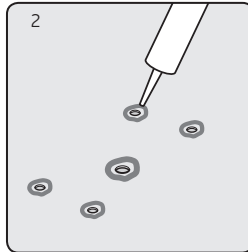
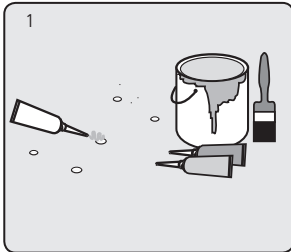

1. When all the holes have been made, apply an appropriate marine sealant to the freshly cut hole edges to help avoid water absorption by the deck.
2. When you are ready to finally install the windlass, apply sealant around all the deck holes. Position the windlass appropriately.
3. Apply some extra sealant into the deck holes and then push four M8 (5/16") mounting bolts, with washers, through the holes. Likewise, if the power wires are being fed under-deck, push the wires through the 12mm (1/2") hole and seal to avoid water ingress using extra sealant. **Take extreme care not to pinch the wires between deck and chassis.**

4.6 Under deck fastening

1. With a helper on deck holding the bolt heads static, tighten up the nuts below-deck until tight. Nylock nuts or Loctite is recommended. Use washers.
- NOTE: If using silicone or other rubbery type sealant, it is advisable to allow curing of the sealant before final tightening of the mounting nuts.

⊘ DO NOT use a permanent adhesive/sealant eg.5200

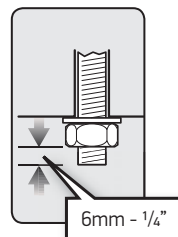

5- Electrical wiring

⚠ WARNING!

Lewmar recommends that the installation complies with USCG, ABYC, NMMA or other local regulations. If you are not sure you understand these guidelines, seek professional help.

5.1 Power source

The windlass must be connected to a suitable 12V DC supply.

The power source must be suitably sized for the expected duration of windlass use. If using a battery, the cold-cranking ampere rating must be 300CCA or higher.

The windlass is fitted with an integrated 30A circuit breaker for overload protection. The button will pop out when overload occurs. Push in to reset. Do not hold button in to attempt to over-ride. DO NOT remove circuit breaker from unit or otherwise bypass.

The windlass is supplied with a 1m cable to allow through-deck connection to a 12V power source.

Installations must use circuit protection to protect the wiring between the power source and the windlass. This protection should be rated higher than 30A. Refer to ABYC or equivalent standards for exceptions and restrictions.

5.2 Electric cable selection

If the distance to the power source is greater, the wires must be extended appropriately and increased in size dependant on length. The table below gives a recommended cable specification based on total wiring length (total wiring length = A+B from wiring diagram below).

CABLE SIZING FOR LENGTH OF CABLE RUN

Up to 14 m	Up to 40 ft	15 - 24 m	41 - 66 ft
10 mm ²	8 AWG	16 mm ²	6 AWG

ⓘ DO NOT confuse cable length with the length of the vessel

Windlass performance is directly related to cable size and length. Voltage drop over the complete wiring run must not exceed 10%.

5.3 Wiring

The wiring system should be fully insulated, which avoids possible electrolytic corrosion problems. We recommend the use of type III stranded, tinned copper wire with copper crimp terminals. Most modern installations are negative return (negative ground) but polarity should be checked.

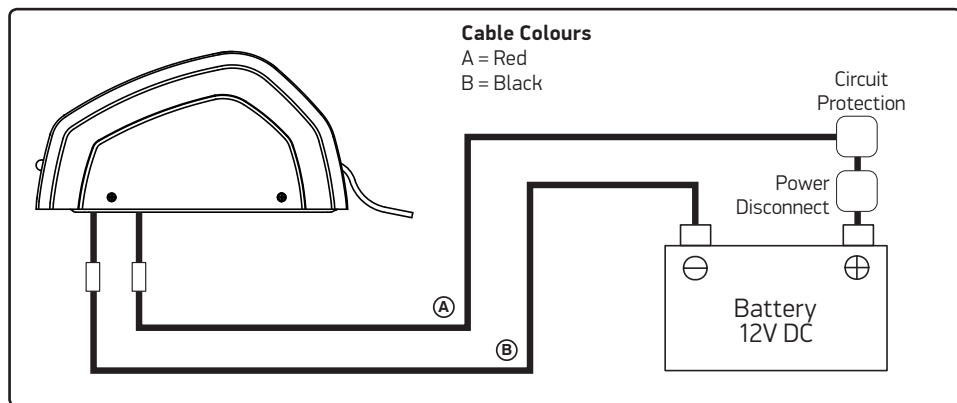

6- Operation

First check that power is turned on to the windlass and that the circuit breaker is not tripped (push the button in to reset).

To drop anchor:

1. Release any anchor locks
2. Hold down on the integrated rocker switch
3. Release button when the desired length of rode has been deployed.

To raise anchor:

1. Hold up on the integrated rocker switch
2. Release when the anchor is approaching the bow-roller
3. Use the controls carefully until the anchor is home.

 **IMPORTANT!**

The CRW400 has 2 electrical control features which may affect the expected functionality of the unit when dropping anchor.

1. "Load Sense" - when the down button is held, there must be a pull on the anchor rode for the CRW's electronics to activate the motor. **If no load is present, the motor will not activate.** For instance, as the anchor hits the sea-bed, you may find the motor stops automatically. As reverse gear is engaged, or the boat drifts away from the anchor, load will increase and the motor will re-activate.

2. "Auto-Stop" - a sensor on the slider arm and magnet embedded in the anchor line allows the windlass to automatically cut power to the motor when the unit is close to paying out the full 35m (115ft) length of line. This prevents damage to the unit by retaining a safe number of wraps on the drum. The line can be retrieved as normal.

6.1 Standard windlass operating procedures

This is an anchor recovery device. **DO NOT** use the windlass to pull the boat to the anchor as it will damage the mechanism. **DO NOT** use the windlass to free a fauled anchor, use a secure fixed point on the deck to break the anchor free.

 When retrieving anchor do not overload or stall the windlass.

When anchoring, power rode out allowing the vessel to take up stern away, thus preventing the rode tangling with anchor and providing enough load to activate the "Load Sense" feature. Use this method also for mooring stern first to a jetty.

To aid recovery, slowly and safely power the vessel at idle speed towards the anchor but not over and beyond, as this can cause damage to topsides.

As anchor approaches the bow roller, use careful adjustments of controls to avoid damaging vessel. Start and stop the windlass to bring the anchor slowly into the bow roller.

Pulling the last bit of rode and anchor into the bow roller at full speed can damage the boat, bow roller and windlass.

7- Servicing

 **WARNING!** Isolate the windlass using circuit breaker/isolator

 **WARNING!** Ensure rode is adequately secured to an independent strong point

The service period is determined by the frequency of use. Professional users will need to carry out these operations more often than the weekend user. Before commencing any work on this or any other electrical product, isolate from the power source.

Bedding in period:

When new there are some areas that will need frequent checking. If no movement is found they can be inspected less often.

- Check mounting bolts are tight and tighten if required.

Annually or more often if frequent user:

- Use light machine oil sparingly to lubricate slider arm rails (item 3)
- Examine all electrical connections, to make sure they are sound and corrosion hasn't set in. Tighten if necessary and protect if required.
- Check mounting bolts and tighten if required.
- Check rode for wear.
- Check main case for damage

8- Troubleshooting

1. Failure to power anchor down.

- Check that power to the motor is turned on and that the inbuilt circuit breaker is not tripped (press button in to reactivate), as well as checking the secondary circuit protection device.
- Ensure that there is sufficient load on the windlass - if the load sense device is not detecting load, then the motor will not turn when down is pressed.
- Ensure that you are not at maximum extension of rope deployment - in this case the reed sensor will activate and prevent further pay-out, although hauling should still work.
- Check all wiring connections and that voltage is reaching the motor wires when the down button is pressed. If so, the motor has become defective and must be changed.

2. Failure to power anchor up.

- Check that power to the motor is turned on and that the inbuilt circuit breaker is not tripped (press button in to reactivate), as well as checking the secondary circuit protection device.
- Operate the up switch. Check voltage is reaching the motor wires. If so, the motor has become defective and must be changed. If not, then either the PCB or switch gear has become defective and must be changed.

3. Rope is not laying properly / becoming tangled

- This indicates that the haul speed and slider arm is not synchronised correctly for the rope.
- Rope specification is crucial to the correct functioning of the unit and therefore only the genuine Lewmar CRW rope kit.

9. Parts list

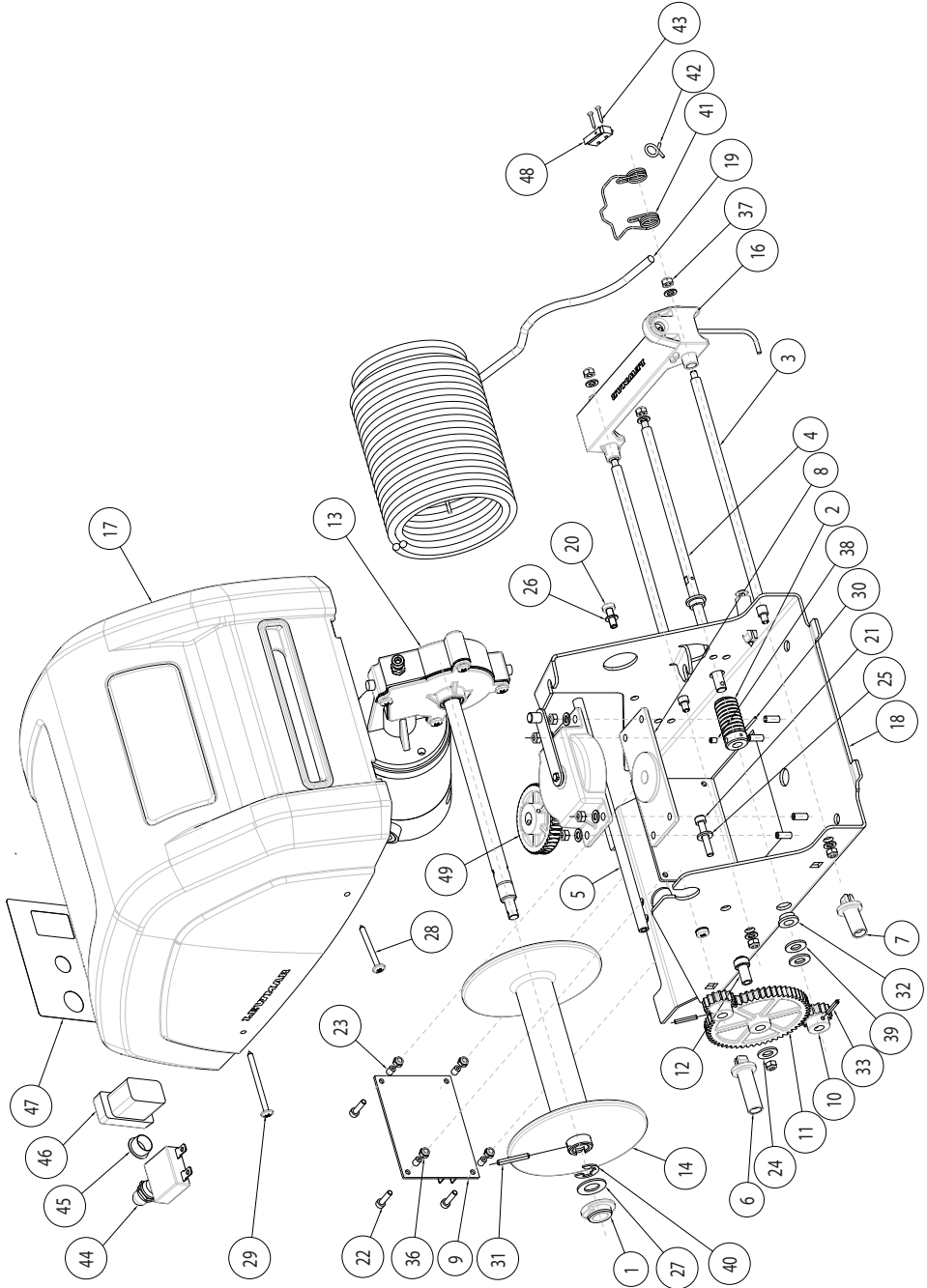

KIT NO	DESCRIPTION	ITEMS INCLUDED (QTY)
66000777	Side Gears Kit	11(1), 10(2), 33(2)
66000778	Worm Gear Kit	2(1), 49(1)
66000779	Slider Arm Assembly	16(1)
66000780	Drum/Rope Kit	14(1), 19(1)
66000781	Motor Kit	13(1)
66000782	PCB Kit	9(1), 22(4), 23(4), 36(4)
66000783	Cover Kit	6(2), 7(2), 17(1), 28(2), 29(2)
66000784	Gear Housing Kit	8(1), 15(1)
66000785	Worm Drive Shaft Kit	4(1), 32(2), 39(1), 37(1), 10(1), 33(1)
66000786	Electrics Kit	46(1), 44(1), 48(1), Reed Sensor(1), Loom (1)
66000787	Fastenings Kit	20(2), 21(1), 22(4), 24(1), 25(1), 26(11), 27(1), 28(2), 29(2), 31(1), 33(2), 36(4), 37(4), 38(1), 39(2), 40(1), 43(2)

9- Warranty

Limited Warranty and Key Terms of Supply by Lewmar

Lewmar warrants that in normal private pleasure boat usage and with proper maintenance its products will conform with their specification for a period of three years from the date of purchase by the end user, subject to the conditions, limitations and exceptions listed below. Any product which proves to be defective in normal usage during that three-year period, will be repaired or, at Lewmar's option, replaced by Lewmar.

A CONDITIONS AND LIMITATIONS

- i Lewmar's liability shall be limited to the repair or replacement of any parts of the product which are defective in materials or workmanship.
- ii Responsibility for the selection of products appropriate for the use intended by the Buyer shall rest solely with the Buyer and Lewmar accepts no responsibility for any such selection.
- iii Lewmar shall not be liable in any way for Product failure, or any resulting loss or damage that arises from:
 - a. use of a product in an application for which it was not designed or intended;
 - b. corrosion, ultra violet degradation or wear and tear;
 - c. a failure to service or maintain the product in accordance with Lewmar's recommendations;
 - d. faulty or deficient installation of the product (unless conducted by Lewmar);
 - e. any modification or alteration of the product;
 - f. conditions that exceed the product's performance specifications or safe working loads.
- g. Abuse
- iv Product subject to a warranty claim must be returned to the Lewmar outlet that supplied the product for examination unless otherwise approved by Lewmar in writing.
- v This warranty does not cover any incidental costs incurred for the investigation, removal, carriage, transport or installation of product.
- vi Service by anyone other than authorized Lewmar representatives shall void this warranty unless it accords with Lewmar guidelines and standards of workmanship.
- vii Lewmar's products are intended for use only in the marine environment. Buyers intending to use them for any other purpose should seek independent professional advice as to their suitability. Lewmar accepts no liability arising from such other use.

B EXCEPTIONS

Cover under this Warranty is limited to a period of one year from the date of purchase by the end user in the case of any of the following products or parts of products:

- Electric motors and associated electrical equipment
- Electronic controls
- Hydraulic pumps, valves and actuators
- Hatch & Portlight weather seals
- Products used in "Grand Prix" racing applications
- Products used in commercial or charter applications
- Anchor rode

C LIABILITY

- i Lewmar's liability under this warranty shall be to the exclusion of all other warranties or liabilities (to the extent permitted by law). In particular (but without limitation):

- a. Lewmar shall not be liable for:

- Any loss of anticipated turnover or profit or indirect, consequential or economic loss;
- Damages, costs or expenses payable to any third party;
- Any damage to yachts or equipment;
- Death or personal injury (unless caused by Lewmar's negligence).

Some states and countries do not allow the exclusion or limitation of incidental or consequential damages, so the above limitation or exclusion may not apply to you

- b. Lewmar grants no other warranties regarding the fitness for purpose, use, nature or satisfactory quality of the products.
- ii Where applicable law does not permit a statutory or implied warranty to be excluded, then such warranty, if permitted by that state or country's law, shall be limited to a period of one year from the date of purchase by the end user. Some states and countries do not allow limitations on how long an implied warranty lasts, so this limitation may not apply to you.

D PROCEDURE

Notice of a claim for service under this warranty shall be made promptly and in writing by the end user to the Lewmar outlet that supplied the product or to Lewmar Limited at Southmoor Lane, Havant, Hampshire PO9 1JJ, England.

E SEVERANCE CLAUSE

If any clause of this warranty is held by any court or other competent authority to be invalid or unenforceable in whole or in part, the validity of the remaining clauses of this warranty and the remainder of the clause in question shall not be affected.

F OTHER RIGHTS

This warranty gives you specific legal rights, and you may also have other legal rights, which vary from state to state and country to country.

In the case of European States a Consumer customer (as defined nationally) has legal rights under the applicable national law governing the sale of Consumer Goods; this Warranty does not affect those rights.

G LAW

This warranty shall be governed by and read in accordance with the laws of England or the state or country in which the first end user is domiciled at the time of purchase of the product.

H DISPUTES

Any dispute arising under this warranty may, at the option of the end-user, be referred to alternative dispute resolution under the rules of the British Marine Federation or to the Courts of the State whose law shall govern the warranty or to the Courts of England and Wales.

The British Marine Federation may be contacted at Marine House, Thorpe Lea Road, Egham, England, TW20 8BF

UK & International Distribution

Lewmar Ltd.
Southmoor Lane
Havant
Hampshire
PO9 1JJ
England

Tel: +44 (0)23 9247 1841
Fax: +44 (0)23 9248 5720
Email: info@lewmar.com

USA

Lewmar
351 New Whitfield Street
Guilford, CT
06437
USA

Tel: +1 203 458 6200
Fax: +1 203 453 5669
Email: info@lewmarusa.com

LEWMAR®

www.lewmar.com

Part No B10416 iss.2